



MEDALIST PRO HARD DRIVE INSTALLATION GUIDE

Medalist Pro 9140 (ST39140A)
Medalist Pro 6530 (ST36530A)
Medalist Pro 4520 (ST34520A)
for ATA (IDE)-Compatible PCs

THE EASIEST WAY TO INSTALL YOUR DRIVE

DiscWizard™ is a revolutionary new Windows program that makes it easy to install your Seagate Medalist Pro drive.



DiscWizard helps you configure your new drive and your computer. It analyzes your system, lets you select various installation options and creates customized step-by-step instructions. It also allows older computers to access the full capacity of large hard drives.

You can run DiscWizard to install your new hard drive if:

- You already have an existing, bootable hard drive in your computer with at least 3 Mbytes of available disc space *and*
- You are running Windows 3.x or Windows 95.

If you can run DiscWizard, follow the instructions on the DiscWizard diskette to install your drive. Refer to this installation guide if you need additional information.

If you cannot run DiscWizard, follow the instructions in this installation guide to install and configure your new drive. This symbol:  indicates that additional information on a topic appears on the back of this sheet.



MULTIMEDIA READY

1. ONE DRIVE OR TWO?

If your new Seagate® drive will be the only drive in your computer, you do not have to change any jumper settings. In this case, skip ahead to "Attaching Cables and Mounting the Drive."



If you already have one hard drive in your computer and you are installing a second drive, you must configure one drive as a master and the other as a slave. The master drive will be the "boot" drive (drive C), from which the computer loads system software when it first starts up. The drive is configured at the factory for one drive only or master drive, with a jumper installed on pins G and H (see below). To configure the drive as a slave, remove all the jumpers. The horizontal jumper on pins A and C is a spare and does not affect drive operation. If you need to change the jumpers on your existing hard drive, see the Disk Manager online manual, or contact the drive manufacturer.

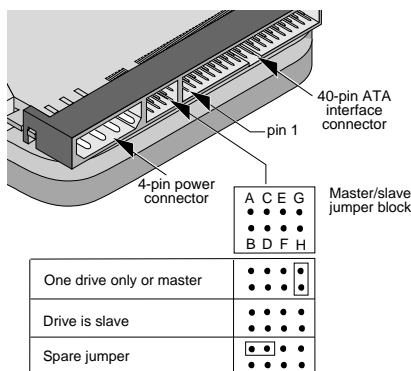

ATTACHING CABLES AND MOUNTING THE DRIVE

- 1 If you are installing a new ATA interface cable, attach one end of the cable to the interface connector on your computer or host adapter. The ATA cable must be no more than 18 inches long.
- 2 Thread the interface cable through the drive bay and attach the connector at the end of the interface cable to your new drive. If you have two drives, attach the second drive to the second connector.

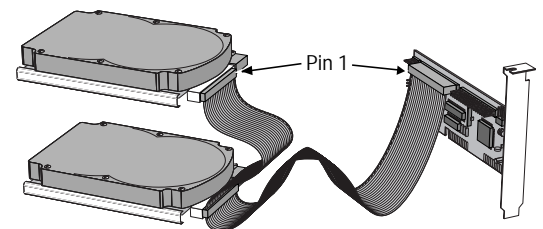

Caution. Make sure to align pin 1 on the computer or host adapter interface connector with pin 1 on your drive or drives. Pin 1 on the interface cable is usually indicated by a stripe along the edge of the cable.

WHAT YOU WILL NEED

- Straight-edge and Phillips screwdrivers
- Drive mounting screws
- An ATA interface cable (max length: 18 inches), and available 40-pin connector.
- An unused drive power cable for your new drive
- A bootable system diskette
- If you are mounting this 3.5-inch drive in a 5.25-inch drive bay, you need a mounting adapter or frame kit. Also, you may need drive mounting rails if your drive bay is not designed for direct mounting.

BEFORE YOU BEGIN

- Make sure your computer is turned off before you open the case.
- Read the handling precautions at the right and inspect the drive to make sure that it is not damaged.
- Save your foam-lined Seagate disc drive box. This box has been approved by Seagate for shipping a Seagate disc drive. Using any other container or packing material voids your drive warranty.

HANDLE WITH CARE!

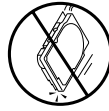

Disc drives are extremely fragile. Do not drop or jar your drive.

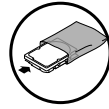

Keep the drive in its antistatic bag until you are ready to install it.



Protect your drive from static discharge by making sure you are well-grounded before touching the drive. We recommend wearing a grounded wrist strap throughout the installation process. Do not touch the connectors or any part of the printed circuit board.

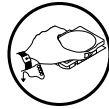

Always handle the drive by its edges or frame.



Do not apply pressure or attach labels to the circuit board or the top of the drive.

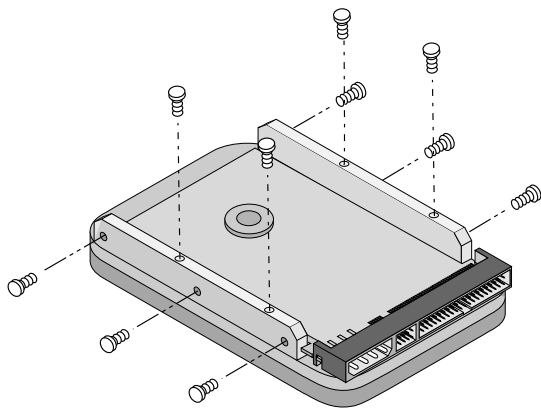

- 3 Slide the drive carefully into the drive bay. Secure the drive with four 6-32 UNC-2A mounting screws in either the side-mounting holes or the bottom-mounting holes. Do not over-tighten the screws. The screws should be inserted no more than 0.22 inch into the bottom mounting holes and no more than 0.14 inch into the side mounting holes. Do not use metric screws.

Note. If you are mounting the drive in a 5.25-inch drive bay, you need a mounting adapter or frame kit. Contact your computer dealer. Some

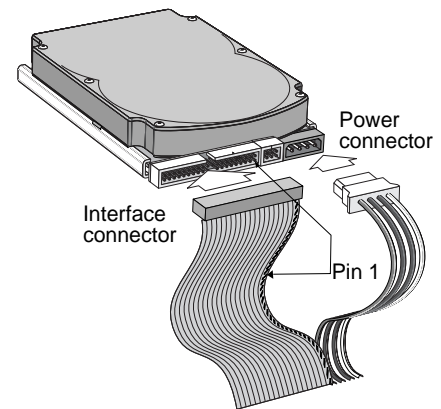

computers also require drive mounting rails, which can be obtained from your distributor or computer manufacturer.

- 4 Attach a power cable to each drive. If your computer does not have an unused power connector, you can purchase a Y-shaped power cable from your computer dealer.
- 5 Check all cable connections and then replace your computer cover. Continue to step 2 below.

2. CONFIGURING YOUR COMPUTER

Before you format or partition your new drive, you must configure your computer's BIOS so that the computer can recognize your new drive.

- 1 Turn your computer on. As your computer starts up, watch the screen for a message describing how to run the system setup program (sometimes called BIOS or CMOS setup). This is usually done by pressing a special key, such as DELETE, ESC, or F1, during startup. See your computer manual for details. Press the appropriate key to run the system setup program.

- 2 Enable LBA mode if it is available. Many BIOS use the logical block addressing (LBA) mode to access drives with capacities greater than 528 Mbytes.

- 3 If your BIOS provides automatic drive detection (an "Auto" drive type), select this option. This allows your computer to configure itself automatically for your new drive.

If your BIOS does not provide automatic drive detection, select "User-defined" drive settings. If your computer supports LBA addressing, enter the LBA cylinder, head and sector values for your drive from the table at the top of the next column. If your computer does not support LBA addressing, enter the CHS values from the table.

Note. Set the *write precomp* or *landing zone* parameters to zero.

BIOS Settings	Cylinders	Heads	Sectors
ST39140A			
CHS addressing	16,383	16	63
Addressable sectors	17,803,490		
ST36530A			
LBA addressing	841	240	63
CHS addressing	13,456	15	63
Addressable sectors	12,715,920		
ST34520A			
LBA addressing	587	240	63
CHS addressing	9,408	15	63
Addressable sectors	8,890,560		

- 4 Save the settings and exit the System Setup program (your computer will automatically reboot).

We recommend that you use Disk Manager to partition and format your drive, *especially if your computer was built before mid-1994*. See Section 3A, "Installation Using Disk Manager," below. If you do not want to use Disk Manager, you can use the standard DOS commands to partition and format your drive, as described in Section 3B.

3A. INSTALLATION USING DISK MANAGER

- 1 Boot your computer from a bootable DOS diskette (use MS DOS Version 5.0 or later). Booting from a diskette ensures that the Disk Manager installation does not conflict with any terminate-and-stay-resident (TSR) programs.

- 2 Insert your DiscWizard diskette. The Disk Manager software is stored on this diskette.

- 3 At the DOS prompt, type **DM** and press ENTER.

- 4 Follow the onscreen instructions until you see the *Select an Installation Option* menu.

- 5 Select either *(E)asy Disk Installation* or *(A)dvanced Disk Installation*.

Because DOS computers cannot access partitions larger than 2.1 Gbytes, Disk Manager may have to divide your hard drive into multiple partitions. If you select *(E)asy Disk Installation*, Disk Manager creates a 2.1-Gbyte partition and a second partition using the remainder of your hard disc. However, if most of your files are smaller than 50 Kbytes, you may want to create several smaller partitions to make more efficient use of your hard disc space. To create smaller partitions, select *(A)dvanced Disk Installation* from the Disk Manager main menu.

- 6 At this point, Disk Manager lists all the hard drives that it can recognize. You should see your new Seagate drive and your existing hard drive, if any.

If any hard drive is not recognized, exit Disk Manager and turn off your computer. Check all cables, jumpers and BIOS settings. Then start at step 1 to run Disk Manager again.

- 7 If Disk Manager recognizes all your drives, select the drive you want to install and press ENTER. Disk Manager partitions and formats the drive. If your new drive is the master drive (Drive C), Disk Manager also configures the drive so that you can boot from it.



Note. If your computer cannot accommodate hard drives with capacities greater than 528 Mbytes, Disk Manager installs a *Dynamic Drive Overlay (DDO)* on your hard disc. If this driver has been installed, you should see a blue Disk Manager banner each time you boot your computer. See the Disk Manager online manual for details.

- 8 Follow the instructions in the post-installation screens.

YOU'RE DONE!

Some DOS-based computers and operating systems are not designed to accommodate large hard disc drives. The three most common system limitations are listed below, along with methods for overcoming these limitations. See your system manual to determine which (if any) of these limitations applies to your computer.

528-Mbyte limit: The BIOS in some older computers cannot accommodate drives with capacities greater than 528 Mbytes. Seagate provides free Disk Manager software with your drive to overcome this limitation. Alternatively, you can purchase a hard drive controller or a BIOS upgrade that supports drives with capacities greater than 528 Mbytes.

 The 32-bit disk access feature in Windows 3.1 does not work with drives that have capacities greater than 528 Mbytes. If you want to use 32-bit disk access with Windows 3.1, install the Seagate replacement driver 32-bit access driver, SEG32BIT.386 located on your DiscWizard diskette. For more information, refer to the back sheet of this poster.

 **4,092-cylinder limit:** The BIOS in some computers cannot support drives that have more than 4,092 cylinders. *If you install a drive that has more than 4,092 cylinders in one of these computers, the computer may “freeze” or fail to boot.* If this occurs, see “Advanced Troubleshooting” on the back side of this sheet.

8.4 Gbyte-limit: If your drive's capacity is greater than 8.4 Gbytes, the capacity may exceed the limits of your system BIOS and operating system. DOS and Windows operating systems and most system BIOS limit the drive partitions to 8.4 Gbytes per physical drive. Because of this limitation, a 32-bit file allocation table (FAT32) is needed to support drive capacities greater than 8.4 Gbytes.

To achieve your drive's full capacity, you need a Windows operating system that supports FAT32 *and*, device support for drives greater than 8.4 Gbytes, from one of the following:

- Third-party device driver, such as Disk Manager (Disk Manager is provided on the DiscWizard diskette included with your drive), *or*

- An intelligent ATA Host Adapter, *or*

 • A system BIOS upgrade. Refer to the back of this sheet for BIOS upgrade information.

3B. STANDARD DOS INSTALLATION

 **Caution.** Partitioning or formatting a drive erases all data on it. Seagate assumes no liability if you erase your data.

Drive Partitioning

Partitioning a hard drive divides it into sections (partitions) that function as separate logical drives (labeled C, D, E, etc.). Because DOS computers cannot access partitions larger than 2.1 Gbytes, you must divide large-capacity hard drives into multiple partitions. In creating partitions, keep in mind that the larger the partition, the more drive space is taken up in unused clusters. To partition your new drive:

- 1 Insert a bootable DOS diskette in your diskette drive and restart your computer (We recommend using DOS Version 5.0 or later).
- 2 Insert a DOS program diskette that contains the FDISK.EXE and FORMAT.COM programs into your diskette drive. At the A: prompt, type **FDISK** and press **ENTER**.
- 3 If you have two hard drives installed, the FDISK menu displays five options. Option five allows you to select the drive you want to partition. Make sure that your new drive is selected.

- 4 Select “Create DOS partition or logical DOS drive” by pressing **1**. Then press **ENTER**.
- 5 Select “Create primary DOS partition” by pressing **1** again. Then press **ENTER**. Create your first drive partition. If you are creating a partition that will be used to boot your computer (drive C), make sure that the partition is marked *active*.
- 6 Create an extended partition and additional logical drives, as necessary, until all the space on your new hard drive has been partitioned.
- 7 When the partitioning is complete, reboot your computer.

Drive Formatting

At the A: prompt, type **format x: /s**, where x is the letter of your first new partition. Repeat this process for all the new partitions you have created.

 **Caution.** Make sure to use the correct drive letters so that you do not format a drive that already contains data.

After you format your drive, it is ready to use.

YOU'RE DONE!

ADDITIONAL INSTALLATION OPTIONS

Cable Select Jumper

Some computers differentiate between master and slave drives using specially designed interface cables that have the line to pin 28 (the Cable Select pin) removed or cut at one connector. The connector that has pin 28 disabled is used for the slave drive. See your computer manual to determine whether your computer supports this feature. To configure your Seagate drive for cable select, place a jumper on pins E and F as shown below.

Remote LED Connection

You can connect a remote LED to pins C (-) and D (+) as shown in the figure below. Do not install a jumper on these pins. Because the jumper block uses a 0.1-inch connector, you may need to replace the current connector. Use Seagate connector part number 10562-001 or equivalent.

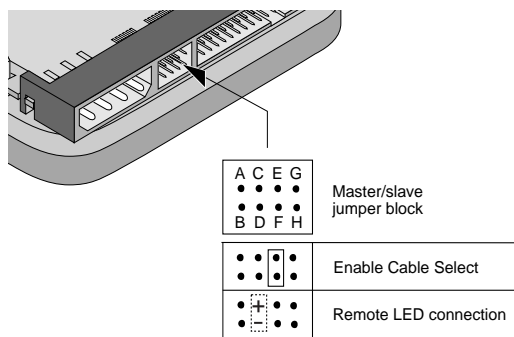

ADVANCED DISK MANAGER OPTIONS

The Disk Manager Online Manual

Disk Manager contains an extensive online manual. This manual includes detailed installation instructions, troubleshooting and a list of master/slave jumper settings for many popular hard drives. To view the Disk Manager online manual, insert the Disk Manager diskette into drive A and type **A:\DM /H**. Then press **ENTER**. You can also view the online manual from within Disk Manager by selecting *(V)iew/Print Online Manual* in the main menu.

Booting from a Diskette

If Disk Manager installs the dynamic drive overlay (DDO) to access the full capacity of your drive, the DDO must load into memory before the operating system loads. This occurs automatically when you boot from your drive. However, if you boot from a diskette, the DDO will not be loaded and you will not be able to access your hard drive. The following procedure allows you to boot from a diskette and still access your hard drive.

- 1 Boot the computer from the hard disc (with no diskette in the diskette drive).
- 2 When the Disk Manager banner appears on the screen, immediately press the **SPACEBAR** (you have about 2 seconds).
- 3 Insert your boot diskette and press the **SPACEBAR** again.

If you boot from a diskette regularly, you can create a Dynamic Drive Overlay boot diskette. It loads DDO into memory, then loads the operating system. See the Disk Manager online manual for more information about creating a dynamic drive overlay boot diskette.

Supported Operating Systems

The Disk Manager dynamic drive overlay provides support for drives

TROUBLESHOOTING

Basic Troubleshooting

If you have installed your drive and it does not function properly, perform the following basic checks:



Warning. Always turn off the computer before changing jumpers or unplugging cables and cards. Wear a ground strap or take other antistatic precautions while working on your computer or handling your drive.

- **Verify compatibility.** Verify that the host adapter and drive are appropriately matched to each other and to your computer. Refer to the relevant documentation for details.
- **Check all cards.** Verify that all cards are seated in their slots on the motherboard and secured with mounting screws.
- **Check all connectors and cables.** Make sure all ribbon and power cables are securely connected. Ribbon cables are easily damaged, especially at the connector. Try a new cable known to be good. Make sure no connector pins are bent. Verify that pin 1 on the interface cable is aligned with pin 1 on the drive and host adapter (see figures and instructions on the front of this sheet).
- **Verify jumper settings.** Review the instructions on this sheet and in your host adapter installation guide. Make sure all appropriate jumpers are installed or removed as necessary.
- **Check your power-supply specifications.** Each time you add a new device to your computer, make sure your computer's internal power supply can support the total power demand. If necessary, consult your dealer for a new power supply.
- **Verify the drive-type settings in the system setup program.** The drive-type settings in the system BIOS must not exceed the physical specifications of your drive. Also, the settings must not exceed the limitations set by the operating system and BIOS.
- **Check for viruses.** Before you use someone else's diskette in your system for the first time, scan the diskette for viruses.

Advanced Troubleshooting

If you have performed the preceding basic checks but the problem persists, follow these guidelines for troubleshooting specific cases.

After you install your new drive, your computer will not boot, and no error message shows on the screen.

- Check your computer manual or BIOS manufacturer to determine whether your BIOS supports drives that have more than 4,096 cylinders. If your system has this limitation, use the following procedure to configure your computer:
 - 1 Turn off your computer, open the case, and remove your new Seagate drive.



Caution. To avoid electrostatic discharge damage to your computer or hard drive, make sure you are well-grounded before touching the drive, cable, connector or jumpers.

- 2 Place a jumper on pins A and B on the master/slave jumper block as shown below. This enables the alternate capacity option that causes the drive to appear to your BIOS as having a 2.1-Gbyte capacity (4,092

- Check for I/O address conflicts. To isolate the conflict, verify that the drive and host adapter are compatible with your computer. Turn off the computer and remove all the peripheral adapter cards except for the video card and host adapter. If the computer recognizes the drive when you reboot the computer, turn off the computer. Reinstall the other peripheral cards, one at a time, until the conflict reoccurs. After you have isolated the source of the address conflict, you can resolve the conflict by changing the I/O address of the peripheral that appears to cause the conflict.
- If Disk Manager has installed the DDO on your hard drive and you have booted directly from a diskette, the information in the boot record for the drive may not have been loaded. Make sure there is no diskette in Drive A and reboot. If you want to boot from the diskette, follow the "Booting with a Diskette" instructions under "Advanced Disk Manager Options."

The dealer partitioned and formatted the drive for you in the store, but the drive does not respond when you install it.

- Reboot the computer and make sure the drive spins up. Check all cables.
- Make sure the power supply is adequate for system needs.
- Make sure the DOS version the dealer used to partition and format the drive is the same version you have installed in your computer. If it isn't, see your dealer.
- Verify the drive-type values in the system setup program. You must install the drive using the same drive-type values your dealer used to partition the drive.
- Check for I/O address conflicts between peripheral cards.
- Check for viruses.

The system hangs in FDISK or fails to create or save the partition record.

- Check all cables.
- Your DOS diskette may be corrupted. Try using a backup DOS diskette.
- Make the partitions smaller.
- Change the interrupt jumper setting on the host adapter.
- Some BIOS have a Track 0 protection feature that protects Track 0 from viruses. This may cause FDISK to hang the system. You must disable this feature in the system setup program before you can use FDISK. See your computer reference guide for assistance. Be sure to re-enable this important feature when FDISK is done.

The system error message, "Drive not Ready," appears.

- Check all cable connections. Make sure pin 1 of the drive is connected to pin 1 of the hard-disc controller or host adapter.
- Make sure the power supply is adequate for system needs.
- Reboot the computer and make sure the drive spins up.

The FDISK error message, "No Fixed Disk Present," appears.

- Make sure the power supply is adequate for system needs.
- Verify the drive-type values in the system setup program.
- Check for I/O address conflicts.

The drive does not format to full capacity.

- Verify the drive-type values in the system setup program. One of the following problems may have occurred:
 - The values may be set with an incorrect translation characteristic.
 - You may have entered a parameter value that exceeds the physical capacity of the drive.
 - You entered a translation characteristic that does not take advantage of the drive's full capacity.

SEAGATE TECHNICAL SUPPORT SERVICES

If you need assistance installing your drive, consult your dealer. Dealers are familiar with their unique system configurations and can help you with system conflicts and other technical issues. If you need additional assistance with your Seagate drive or other Seagate products, use one of the Seagate technical support services listed below.

SeaFONE®

1-800-SEAGATE

Seagate's 800 number (1-800-732-4283) allows toll-free access to automated self-help services, providing answers to commonly asked questions, troubleshooting tips and specifications for disc drives and tape drives. This service is available 24 hours daily and requires a touch-tone phone. International callers may reach this automated self-help service by dialing 408-456-4496.

Online Services

SeaNET™

You can obtain technical information about Seagate products over the Internet from Seagate's World Wide Web home page (<http://www.seagate.com>) or Seagate's ftp server (<ftp://ftp.seagate.com>). You can also send e-mail with your technical questions to discsupport@seagate.com.

Seagate CompuServe Forum

Online technical support for Seagate products is available on CompuServe. To access our technical support forum, type **go seagate**. This forum provides information similar to that found on SeaBOARD. In addition, you can type questions or browse through previous questions and answers on the forum messages.

SeaBOARD®

SeaBOARD is a computer bulletin board system that contains information about Seagate disc and tape drive products and is available 24 hours daily. Set your communications software to eight data bits, no parity and one stop bit (8-N-1).

Location	Phone number	Location	Phone number
Australia	61-2-9756-2359	Taiwan	886-2-2719-6075
France	33 1-48 25 35 95	Thailand	662-531-8111
Germany	49-89-140-9331	UK	44-1628-478011
		USA	405-936-1600

FAX Services

SeaFAX®

You can use a touch-tone telephone to access Seagate's automated FAX system to receive technical support information by return FAX. This service is available 24 hours daily.

Location	Phone number	Location	Phone number
Australia	61-2-9756-5170	UK	44-1628-894084
Germany	49-89-1430-5102	USA	405-936-1620

Seagate Technical Support FAX

You can FAX questions or comments to technical support specialists 24 hours daily. Responses are sent during business hours.

Location	Phone number	Location	Phone number
Australia	61-2-9725-4052	Korea	82-2-556-4251/7395
France	33 1-46 04 42 50	Singapore	65-488-7528
Germany	49-89-1430-5100	Taiwan	886-2-2715-2923
Hong Kong	852-2368 7173	UK	44-1628-890660
Japan	81-3-5462-2979	USA	405-936-1685

Supported Operating Systems

The Disk Manager dynamic drive overlay provides support for drives that have capacities greater than 528 Mbytes under MS-DOS, Windows 3.x, Windows 95, Windows NT 3.51, Windows NT 3.50 (requires DM upgrade drivers), OS/2 V3.0 (Warp full pack), and OS/2 V2.0–3.0 (requires DM upgrade drivers). *Disk Manager does not support 32-bit FAT in Windows 95.*

Before you install a non-DOS operating system on the drive, install DOS and Disk Manager and make sure that the drive is bootable. Instructions for running the dynamic drive overlay with other operating systems are available in the Disk Manager online manual.

Removing the Dynamic Drive Overlay

If Disk Manager installs a dynamic drive overlay (DDO) and you do not need this software to access the full capacity of your drive, you can remove the dynamic drive overlay without losing your data. However, you will lose access to the full capacity of your drive unless you have another method for accessing high-capacity drives (see *Addressing Drive-Capacity Limitations* on the front side of this sheet). Follow the instructions below to remove a DDO from a drive.



Caution. Before you attempt to remove a DDO, make a backup copy of all the data on your hard disc. Also, run CHKDSK, SCANDISK or a third-party equivalent to detect and repair any damaged files before you follow the procedure below. If the DDO migration program encounters a serious file problem or is interrupted by a power loss or hardware failure, the migration will fail and your data will be lost.

- 1 Boot the computer to Drive C.
- 2 Insert your DiscWizard diskette into Drive A.
- 3 Type **A:\DM** to start Disk Manager.
- 4 Select the *Select Installation Options Menu*.
- 5 Select *(M)aintenance Menu*.
- 6 Select *(M)igrate Dynamic Drive*. This program moves the data on your drive so that it can be accessed without the DDO. The migration may take up to an hour to complete, depending on the size of your drive.
- 7 When the migration program has finished, exit Disk Manager.
- 8 Remove the diskette and reboot the computer. Enter your system setup program (see your system manual for details).
- 9 Configure the hard drive with the Cylinder/Head/Sector parameters shown for your drive in the table in Section 2, "Configuring Your Computer," on the front side of this sheet. Save your changes and exit the system setup program.
- 10 When your computer has rebooted, insert the DiscWizard diskette into drive A.
- 11 Type **A:\DM** and choose the *Maintenance Menu*.
- 12 Select *Uninstall (D)isk Manager*.
- 13 Select the correct drive to uninstall.
- 14 When the uninstall is complete, exit Disk Manager and reboot.

Note. Disk Manager can also remove a drive overlay placed by the EZ-Drive program. Select *(C)onvert Drive Format* from the Maintenance Menu.

shown below. This enables the alternate capacity option that causes the drive to appear to your BIOS as having a 2.1-Gbyte capacity (4,092 cylinders, 16 heads, 63 sectors per track). You may need third-party partitioning software, such as Disk Manager, to achieve full capacity of the drive.

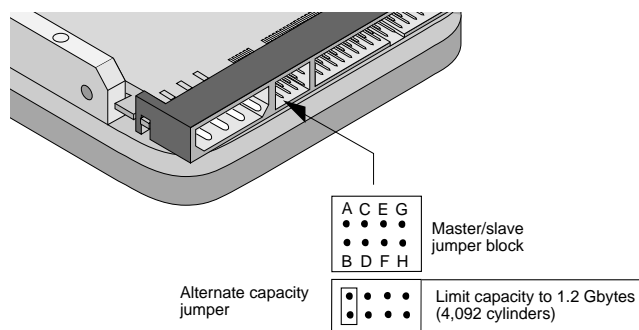

- 3 Remount your drive in the computer and replace the computer cover.
- 4 Insert a bootable DOS diskette into drive A and turn on the computer. It should boot from drive A and automatically detect the new drive as a 2.1-Gbyte drive.
- 5 Insert your DiscWizard diskette into drive A and type **A:\DM**. Then press **ENTER**. This runs the Disk Manager program.
- 6 Follow the Disk Manager instructions to install the dynamic drive overlay and to partition and format your new drive to its full capacity.
- 7 After Disk Manager is done, reboot your system. You should see the Disk Manager banner and be able to access the full capacity of your new drive.

The screen remains blank when you power up the system.

If the steps listed above do not remedy this problem, try the following:

- Make sure the monitor is plugged in and turned on.
- Check all cards.
- Make sure the video card is seated in its slot and secured with mounting screws.
- Turn off the computer and remove the drive host adapter. If the screen turns on after you reboot, the host adapter may be incompatible or defective. If so, see your dealer.

The system does not recognize the drive.

- Check all cables.
- Make sure the power supply is adequate for system needs.
- Reboot the computer and listen to make sure the drive motor starts up. If the drive is very quiet, it may be difficult to hear its discs reach operating speed. If the drive motor does not start up, recheck all drive cables.
- Verify that for each drive, a drive-type is listed in the system setup program.
- Try rebooting your computer by pressing the **CTRL**, **ALT** and **DELETE** keys simultaneously. If the drive is recognized after you reboot the system, the computer BIOS test may be completing before the drive is ready.

One solution is to slow the processor speed during startup. If your computer has a turbo switch, set it to slow speed before turning the computer on. If there is no turbo switch, you may be able to use keyboard commands; see your computer manual for details. After the computer is up and running, return the processor to the fast speed.

Another solution is to warm-boot your computer after every power-on.

- You entered a translation characteristic that does not take advantage of the drive's full capacity.
- The drive's physical specifications exceed the translation limits imposed by the BIOS.

! Caution. If you change the drive-type values in the system setup program, you must partition and format the drive again. *This erases data on the drive.*

- If you have partitioned the drive into individual logical drives, you may need to make the partitions smaller to access the full drive capacity.
- If your computer supports LBA mode, you may need to enable LBA mode in the system setup program to access the full capacity of the drive. Refer to your computer's reference guide to find out how to enable LBA.
- Your computer may not support drives that have more than 4,096 cylinders. Follow the instructions for *After you install your new drive, your computer will not boot, and no error message shows on the screen.*

The DOS messages "Disk Boot Failure," "Non-System Disk" or "No ROM Basic – SYSTEM HALTED" appear.

- Reinstall the DOS system files using the DOS SYS utility.
- Check all cables.
- Use FDISK to verify that the primary partition is active.
- Check for viruses.

The system error message, "HDD controller failure" appears.

- Confirm the jumper settings on the drive.
- Verify the drive-type settings in the system setup program.

32-bit Disk Access with Windows 3.1

The 32-bit disk access feature in Windows 3.1 does not work with drives that have capacities greater than 528 Mbytes. If you want to use 32-bit disk access under Windows 3.1, install the Seagate replacement 32-bit access driver, SEG32BIT.386, located on your DiscWizard diskette.

BIOS Upgrades

If you need to upgrade your BIOS, contact the appropriate BIOS manufacturer listed below.

<i>American Megatrends (AMI):</i> 1-800-828-9264	http://www.megatrends.com
<i>Award Software International, Inc.:</i> 1-508-686-6468	http://www.award.com
<i>Microid Research/Mr. BIOS:</i> (Upgrades from <i>Unicore Software</i>)	http://www.mrbios.com 1-800-800-2167
<i>Phoenix Technologies Ltd.:</i> (Upgrades from <i>Microfirmware</i>)	http://www.ptltd.com 1-800-767-5465
<i>SystemSoft:</i>	http://www.systemsoft.com

Direct-Support Services

Seagate Technical Support

For one-on-one help, you can talk to a technical support specialist during local business hours. Before calling, note your system configuration and drive model number (STxxxx).

Location	Phone number	Location	Phone number
Australia	61-2-9725-3366	Singapore	65-488-7584
France	33 1-41 86 10 86	Taiwan	886-2-2514-2237
Germany	49-89-140-9332	UK	44-1628-894083
Hong Kong	852-2368 9918	USA	1-800-SEAGATE or
Korea	82-2-531-5800	USA	405-456-4496

SeaTDD™

405-936-1687

Using a telecommunications device for the deaf (TDD), you can send questions or comments 24 hours daily and exchange messages with a technical support specialist between 8:00 A.M. to 12:15 P.M. and 1:30 P.M. to 6:00 P.M. (central time) Monday through Friday.

STORING AND SHIPPING YOUR DRIVE

Keep your original box and packing materials for storing or shipping your drive. The box has a *Seagate Approved Package* label. Shipping a drive in an unapproved container voids the warranty. Call your authorized Seagate distributor for information on packing materials. The figure to the right shows how a drive fits in an approved single-pack box, including the packing materials.

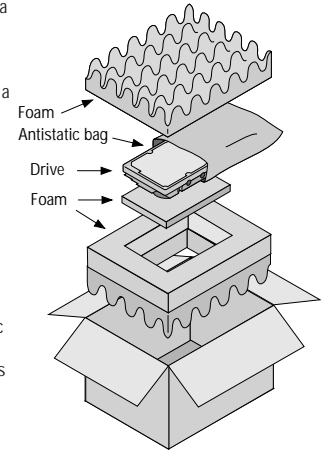

Warranty. See your authorized Seagate distributor or dealer. Preinstalled or bundled software is provided "as is." There are no warranties of merchantability or fitness for a particular purpose. All such warranties are expressly and specifically disclaimed.

Maintenance and repair. Seagate drives do not require maintenance. The head/disc assembly is sealed; a broken seal voids the warranty. Seagate customer-service centers are the only facilities authorized to repair Seagate drives.

Electromagnetic Compliance for the European Union. This model complies with the European Union requirements of the Electromagnetic Compatibility Directive 89/336/EEC of 03 May 1989 as amended by Directive 92/31/EEC of 28 April 1992 and Directive 93/68/EEC of 22 July 1993.

Compliance of this drive, as a system component, was confirmed with a test system. We cannot guarantee that your system will comply. The drive is not meant for external use (without properly designed enclosure, shielded I/O cable, etc.).

Sicherheitsanleitung 1. Das Gerät ist ein Einbaugerät, das für eine maximale Umgebungstemperatur von 55°C vorgesehen ist. **2.** Zur Befestigung des Laufwerkes werden 4 Schrauben 6-32 UNC-2A benötigt. Bei seitlicher Befestigung darf die maximale Länge der Schrauben im Chassis nicht mehr als 3,3 mm und bei Befestigung an der Unterseite nicht mehr als 5,08 mm betragen. **3.** Als Versorgungsspannungen werden benötigt: +5V ± 5% 0,6A; +12V ±% 0,8A (1,9A für ca. 30 Sek. für ± 10%) **4.** Die Versorgungsspannung muss SELV entsprechen. **5.** Alle Arbeiten auf dem Festplatte dürfen nur von Ausgebildetem Servicepersonal durchgeführt werden. Bitte entfernen Sie nicht die Aufschriftenschilder des Laufwerkes. **6.** Der Einbau des Laufwerkes muss den Anforderungen gemäss DIN IEC 950 VDE 0805/05.90 entsprechen.

Seagate, Seagate Technology, and the Seagate logo are registered trademarks of Seagate Technology, Inc. SeaFAX, SeaPHONE, SeaBOARD, SeaNET, SeaTDD, Medalist, the Medalist logo and DiscWizard are either trademarks or registered trademarks of Seagate Technology, Inc. or one of its subsidiaries. All other trademarks or registered trademarks are the property of their respective owners.

Seagate reserves the right to change, without notice, product offerings or specifications. No part of this publication may be reproduced in any form without written permission from Seagate Technology, Inc.

© 1998 Seagate Technology, Inc.
920 Disc Drive, Scotts Valley, CA 95066, USA
Publication Number: 32660-001, Rev. A, January 1998, Printed in USA



MEDALIST PRO HARD DRIVE INSTALLATION GUIDE

Medalist Pro 9140 (ST39140A)
Medalist Pro 6530 (ST36530A)
Medalist Pro 4520 (ST34520A)
for ATA (IDE)-Compatible PCs

THE EASIEST WAY TO INSTALL YOUR DRIVE

DiscWizard™ is a revolutionary new Windows program that makes it easy to install your Seagate Medalist Pro drive.



DiscWizard helps you configure your new drive and your computer. It analyzes your system, lets you select various installation options and creates customized step-by-step instructions. It also allows older computers to access the full capacity of large hard drives.

You can run DiscWizard to install your new hard drive if:

- You already have an existing, bootable hard drive in your computer with at least 3 Mbytes of available disc space and
- You are running Windows 3.x or Windows 95.

If you can run DiscWizard, follow the instructions on the DiscWizard diskette to install your drive. Refer to this installation guide if you need additional information.

If you cannot run DiscWizard, follow the instructions in this installation guide to install and configure your new drive. This symbol  indicates that additional information on a topic appears on the back of this sheet.



MultimediaReady

HANDLE WITH CARE!



Disc drives are extremely fragile. Do not drop or jar your drive.



Keep the drive in its antistatic bag until you are ready to install it.



Protect your drive from static discharge by making sure you are well-grounded before touching the drive. We recommend wearing a grounded wrist strap throughout the installation process. Do not touch the connectors or any part of the printed circuit board.



Always handle the drive by its edges or frame.



Do not apply pressure or attach labels to the circuit board or the top of the drive.

1. ONE DRIVE OR TWO?

If your new Seagate™ drive will be the only drive in your computer, you do not have to change any jumper settings. In this case, skip ahead to "Attaching Cables and Mounting the Drive."

If you already have one hard drive in your computer and you are installing a second drive, you must configure one drive as a master and the other as a slave. The master drive will be the "boot" drive (drive C), from which the computer loads system software when it first starts up. The drive is configured at the factory for one drive only or master drive, with a jumper installed on pins G and H (see below). To configure the drive as a slave, remove all the jumpers. The horizontal jumper on pins A and C is a spare and does not affect drive operation. If you need to change the jumpers on your existing hard drive, see the Disk Manager online manual, or contact the drive manufacturer.

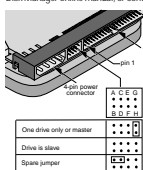

One drive only or master	Drive is slave	Spare jumper

ATTACHING CABLES AND MOUNTING THE DRIVE

1 If you are installing a new ATA interface cable, attach one end of the cable to the interface connector on your computer or host adapter. The ATA cable must be no more than 18 inches long.

2 Thread the interface cable through the drive bay and attach the connector at the end of the interface cable to your new drive. If you have two drives, attach the second drive to the second connector.

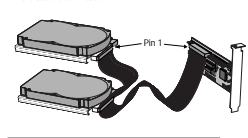

Caution. Make sure to align pin 1 on the computer or host adapter interface connector with pin 1 on your drive or drives. Pin 1 on the interface cable is usually indicated by a stripe along the edge of the cable.

WHAT YOU WILL NEED

- Straight-edge and Phillips screwdrivers
- Drive mounting screws
- An ATA interface cable (max length: 18 inches), and available 40-pin connector
- An unused drive power cable for your new drive
- A bootable system diskette
- If you are mounting this 3.5-inch drive in a 5.25-inch drive bay, you need a mounting adapter or frame kit. Also, you may need drive mounting rails if your drive bays is not designed for direct mounting.

BEFORE YOU BEGIN

- Make sure your computer is turned off before you open the case.
- Read the handling precautions at the right and inspect the drive to make sure that it is not damaged.
- Save your foam-lined Seagate disc drive box. This box has been approved by Seagate for shipping a Seagate disc drive. Using any other container or packing material voids your drive warranty.

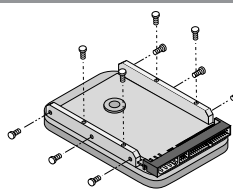

3 Slide the drive carefully into the drive bay. Secure the drive with four 6-32 UNC-2A mounting screws in either the side-mounting holes or the bottom-mounting holes. Do not over-tighten the screws. The screws should be inserted no more than 0.22 inch into the bottom mounting holes and no more than 0.14 inch into the side mounting holes. Do not use metric screws.

Note. If you are mounting the drive in a 5.25-inch drive bay you need a mounting adapter or frame kit. Contact your computer dealer. Some

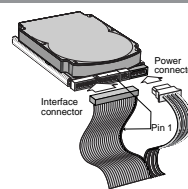

computers also require drive mounting rails, which can be obtained from your distributor or computer manufacturer.

- 4 Attach a power cable to each drive. If your computer does not have an unused power connector, you can purchase a Y-shaped power cable from your computer dealer.
- 5 Check all cable connections and then replace your computer cover. Continue to step 2 below.

2. CONFIGURING YOUR COMPUTER

Before you format or partition your new drive, you must configure your computer's BIOS so that the computer can recognize your new drive.

1 Turn your computer on. As your computer starts up, watch the screen for a message describing how to run the system setup program (sometimes called BIOS or CMOS setup). This is usually done by pressing a special key, such as DELETE, ESC, or F1, during startup. See your computer manual for details. Press the appropriate key to run the system setup program.

2 Enable LBA mode if it is available. Many BIOS use the logical block addressing (LBA) mode to access drives with capacities greater than 528 Mbytes.

3 If your BIOS provides automatic drive detection (an "Auto" drive type), select this option. This allows your computer to configure itself automatically for your new drive.

If your BIOS does not provide automatic drive detection, select "User-defined" drive settings. If your computer supports LBA addressing, enter the LBA cylinder, head and sector values for your drive from the table at the top of the next column. If your computer does not support LBA addressing, enter the CHS values from the table.

Note. Set the write precomp or landing zone parameters to zero.

BIOS Settings	Cylinders	Heads	Sectors
ST39140A			
CHS Addressing	16,383	16	63
Addressable sectors	17,803,490		
ST36530A			
LBA Addressing	841	240	63
CHS Addressing	13,456	15	63
Addressable sectors	12,715,920		
ST34520A			
LBA Addressing	587	240	63
CHS Addressing	9,408	15	63
Addressable sectors	8,890,560		

4 Save the settings and exit the System Setup program (your computer will automatically reboot).

We recommend that you use Disk Manager to partition and format your drive, especially if your computer was built before mid-1994. See Section 3A, "Installation Using Disk Manager," below. If you do not want to use Disk Manager, you can use the standard DOS commands to partition and format your drive, as described in Section 3B.

ADDRESSING DRIVE-CAPACITY LIMITATIONS

Some DOS-based computers and operating systems are not designed to accommodate large hard disc drives. The three most common system limitations are listed below, along with methods for overcoming these limitations. See your system manual to determine which (if any) of these limitations applies to your computer.

528-Mbyte limit: The BIOS in some older computers cannot accommodate drives with capacities greater than 528 Mbytes. Seagate provides free Disk Manager software with your drive to overcome this limitation. Alternatively, you can purchase a hard drive controller or a BIOS upgrade that supports drives with capacities greater than 528 Mbytes.

The 32-bit disk access feature in Windows 3.1 does not work with drives that have capacities greater than 528 Mbytes. If you want to use 32-bit disk access with Windows 3.1, install the Seagate replacement driver 32-bit access driver, SEG32BIT.386 located on your DiscWizard diskette. For more information, refer to the back sheet of this poster.

4,092-cylinder limit: The BIOS in some computers cannot support drives that have more than 4,092 cylinders. If you install a drive that has more than 4,092 cylinders in one of these computers, the computer may "freeze" or fail to boot if this occurs; see "Advanced Troubleshooting" on the back side of this sheet.

8.4 Gbyte-limit: If your drive's capacity is greater than 8.4 Gbytes, the capacity may exceed the limits of your system BIOS and operating system. DOS and Windows operating systems and most system BIOS limit the drive partitions to 8.4 Gbytes per physical drive. Because of this limitation, a 32-bit file allocation table (FAT32) is needed to support drive capacities greater than 8.4 Gbytes.

To achieve your drives full capacity, you need a Windows operating system that supports FAT 32 and, device support for drives greater than 8.4 Gbytes, from one of the following:

- Third-party device driver, such as Disk Manager (Disk Manager is provided on the DiscWizard diskette included with your drive), or
- An intelligent ATA Host Adapter, or
- A system BIOS upgrade. Refer to the back of this sheet for BIOS upgrade information.

3A. INSTALLATION USING DISK MANAGER

1 Boot your computer from a bootable DOS diskette (use MS DOS Version 5.0 or later). Booting from a diskette ensures that the Disk Manager installation does not conflict with any terminate-and-stay-resident (TSR) programs.

2 Insert your DiscWizard diskette. The Disk Manager software is stored on this diskette.

3 At the DOS prompt, type DM and press enter.

4 Follow the onscreen instructions until you see the Select an Installation Option menu.

5 Select either (E)asy Disk Installation or (A)dvanced Disk Installation.

Because DOS computers cannot access partitions larger than 2.1 Gbytes, Disk Manager may have to divide your hard drive into multiple partitions. If you select (E)asy Disk Installation, Disk Manager creates a 2.1-Gbyte partition and a second partition using the remainder of your hard disc. However, if most of your files are smaller than 50 Kbytes, you may want to create several smaller partitions to make more efficient use of your hard disc space. To create multiple partitions, select (A)dvanced Disk Installation from the Disk Manager main menu.

6 At this point, Disk Manager lists all the hard drives that it can recognize. You should see your new Seagate drive and your existing hard drive, if any.

If any hard drive is not recognized, exit Disk Manager and turn off your computer. Check all cables, jumpers and BIOS settings. Then start at step 1 to run Disk Manager again.

7 If Disk Manager recognizes all your drives, select the drive you want to install and press enter. Disk Manager partitions and formats the drive. If your new drive is the master drive (Drive C), Disk Manager also configures the drive so that you can boot from it.

Note. If your computer cannot accommodate hard drives with capacities greater than 528 Mbytes, Disk Manager installs a Dynamic Drive Overlay (DDO) on your hard disc. If this driver has been installed, you should see a blue Disk Manager banner each time you boot your computer. See the Disk Manager online manual for details.

8 Follow the instructions in the post-installation screens.

YOU'RE DONE!

3B. STANDARD DOS INSTALLATION

Caution. Partitioning or formatting a drive erases all data on it. Seagate assumes no liability if you erase your data.

Drive Partitioning

Partitioning a hard drive divides it into sections (partitions) that function as separate logical drives (labeled C, D, E, etc.). Because DOS computers cannot access partitions larger than 2.1 Gbytes, you must divide large-capacity hard drives into multiple partitions. In creating partitions, keep in mind that the larger the partition, the more drive space is taken up in unused clusters. To partition your new drive:

1 Insert a bootable DOS diskette in your diskette drive and restart your computer (We recommend using DOS Version 5.0 or later).

2 Insert a DOS program diskette that contains the FDISK.EXE and FORMAT.COM programs into your diskette drive. At the A: prompt, type FDISK and press enter.

3 If you have two hard drives installed, the FDISK menu displays five options. Option five allows you to select the drive you want to partition. Make sure that your new drive is selected.

4 Select "Create DOS partition or logical DOS drive" by pressing 1. Then press enter.

5 Select "Create primary DOS partition" by pressing 1 again. Then press enter. Create your first drive partition. If you are creating a partition that will be used to boot your computer (drive C), make sure that the partition is marked active.

6 Create an extended partition and additional logical drives, as necessary, until all the space on your new hard drive has been partitioned.

7 When the partitioning is complete, reboot your computer.

Drive Formatting

At the A: prompt, type format x: /s, where x is the letter of your first new partition. Repeat this process for all the new partitions you have created.

Caution. Make sure to use the correct drive letters so that you do not format a drive that already contains data.

After you format your drive, it is ready to use.

YOU'RE DONE!

ADDITIONAL INSTALLATION OPTIONS

Cable Select Jumper

Some computers differentiate between master and slave drives using specially designed interface cables that have the line to pin 28 (the Cable Select) removed or cut at one connector. The connector that has pin 28 disabled is used for the slave drive. See your computer manual to determine whether your computer supports this feature. To configure your Seagate drive for cable select, place a jumper on pins E and F as shown below.

Remote LED Connection

You can connect a remote LED to pins C (-) and D (+) as shown in the figure below. Do not install a jumper on these pins. Because the jumper block uses a 0.1-inch connector, you may need to replace the current connector. Use Seagate connector part number 10562-001 or equivalent.

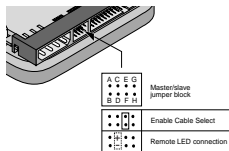

ADVANCED DISK MANAGER OPTIONS

The Disk Manager Online Manual

Disk Manager contains an extensive online manual. This manual includes detailed installation instructions, troubleshooting and a list of master/slave jumper settings for many popular hard drives. To view the Disk Manager online manual, insert the Disk Manager diskette into drive A and type **A:DM.M**. Then press **ENTER**. You can also view the online manual from within Disk Manager by selecting **(View/Print Online Manual)** in the main menu.

Booting from a Diskette

If Disk Manager installs the dynamic drive overlay (DDO) to access the full capacity of your drive, the DDO must load into memory before the operating system loads. This occurs automatically when you boot from your drive. However, if you boot from a diskette, the DDO will not be loaded and you will not be able to access your hard drive. The following procedure allows you to boot from a diskette and still access your hard drive.

- 1 Boot the computer from the hard disc (with no diskette in the diskette drive).
 - 2 When the Disk Manager banner appears on the screen, immediately press the **SPACEBAR** (you have about 2 seconds).
 - 3 Insert your boot diskette and press the **SPACEBAR** again.
- If you boot from a diskette regularly, you can create a Dynamic Drive Overlay boot diskette. It loads DDO into memory, then loads the operating system. See the Disk Manager online manual for more information about creating a dynamic drive overlay boot diskette.

Supported Operating Systems

The Disk Manager dynamic drive overlay provides support for drives that have capacities greater than 528 Mbytes under MS-DOS, Windows 3.x, Windows 95, Windows NT 3.51, Windows NT 3.50 (requires DM upgrade drivers), OS/2 V3.0 (Warp full pack), and OS/2 V2.0-3.0 (requires DM upgrade drivers). Disk Manager does not support 32-bit FAT in Windows 95.

Before you install a non-DOS operating system on the drive, install DOS and Disk Manager and make sure that the drive is bootable. Instructions for running the dynamic drive overlay with other operating systems are available in the Disk Manager online manual.

Removing the Dynamic Drive Overlay

If Disk Manager installs a dynamic drive overlay (DDO) and you do not need this software to access the full capacity of your drive, you can remove the dynamic drive overlay without losing your data. However, you will lose access to the full capacity of your drive unless you have another method for accessing high-capacity drives (see *Addressing Drive-Capacity Limitations* on the front side of this sheet). Follow the instructions below to remove a DDO from a drive.

- 1 **Caution.** Before you attempt to remove a DDO, make a backup copy of all the data on your hard disc. Also, run CHKDSK, SCANDISK or a third-party equivalent to detect and repair any damaged files before you follow the procedure below. If the DDO migration program encounters a serious file problem or is interrupted by a power loss or hardware failure, the migration will fail and your data will be lost.

- 1 Boot the computer to Drive C.
- 2 Insert your DiskWizard diskette into Drive A.
- 3 Type **A:DM** to start Disk Manager.
- 4 Select the **Select Installation Options Menu**.
- 5 Select **(Maintenance Menu)**.
- 6 Select **(Migrate Dynamic Drive)**. This program moves the data on your drive so that it can be accessed without the DDO. The migration may take up to an hour to complete, depending on the size of your drive.
- 7 When the migration program has finished, exit Disk Manager.
- 8 Remove the diskette and reboot the computer. Enter your system setup program (see your system manual for details).
- 9 Configure the hard drive with the **Cylinder/Head/Sector** parameters shown for your drive in the table in Section 2, "Configuring Your Computer," on the front side of this sheet. Save your changes and exit the system setup program.
- 10 When your computer has rebooted, insert the DiskWizard diskette into drive A.
- 11 Type **A:DM** and choose the **Maintenance Menu**.
- 12 Select **Uninstall (D)isk Manager**.
- 13 Select the correct drive to uninstall.
- 14 When the uninstall is complete, exit Disk Manager and reboot.

Note. Disk Manager can also remove a drive overlay placed by the EZ-Drive program. Select **(Convert Drive Format)** from the Maintenance Menu.

TROUBLESHOOTING

Basic Troubleshooting

If you have installed your drive and it does not function properly, perform the following basic checks:

- 1 **Warning.** Always turn off the computer before changing jumpers or unplugging cables and cards. Wear a ground strap or take other antistatic precautions while working on your computer or handling your drive.
- 2 **Verify compatibility.** Verify that the host adapter and drive are appropriately matched to each other and to your computer. Refer to the relevant documentation for details.
- 3 **Check all cards.** Verify that all cards are seated in their slots on the motherboard and secured with mounting screws.
- 4 **Check all connectors and cables.** Make sure all ribbon and power cables are securely connected. Ribbon cables are easily damaged, especially at the connector. Try a new cable known to be good. Make sure no connector pins are bent. Verify that pin 1 on the interface cable is aligned with pin 1 on the drive and host adapter (see figures and instructions on the front of this sheet).
- 5 **Verify jumper settings.** Review the instructions on this sheet and in your host adapter installation guide. Make sure all appropriate jumpers are installed or removed as necessary.
- 6 **Check your power-supply specifications.** Each time you add a new device to your computer, make sure your computer's internal power supply can support the total power demand. If necessary, consult your dealer for a new power supply.
- 7 **Verify the drive-type settings in the system setup program.** The drive-type settings in the system BIOS must not exceed the physical specifications of your drive. Also, the settings must not exceed the limitations set by the operating system and BIOS.
- 8 **Check for viruses.** Before you use someone else's diskette in your system for the first time, scan the diskette for viruses.

Advanced Troubleshooting

If you have performed the preceding basic checks but the problem persists, follow these guidelines for troubleshooting specific cases.

After you install your new drive, your computer will not boot, and no error message shows on the screen.

- 1 Check your computer manual or BIOS manufacturer to determine whether your BIOS supports drives that have more than 4,096 cylinders. If your system has this limitation, use the following procedure to configure your computer:
 - 1 Turn off your computer, open the case, and remove your new Seagate drive.

- 1 **Caution.** To avoid electrostatic discharge damage to your computer or hard drive, make sure you are well-grounded before touching the drive, cable, connector or jumpers.

- 2 Place a jumper on pins A and B on the master/slave jumper block as shown below. This enables the alternate capacity option that causes the drive to appear to your BIOS as having a 2.1-Gbyte capacity (4,092 cylinders, 16 heads, 63 sectors per track). You may need third-party partitioning software, such as Disk Manager, to achieve full capacity of the drive.

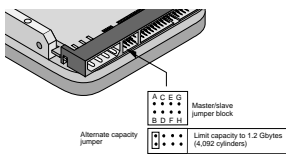

- 3 Reformat your drive in the computer and replace the computer cover.
- 4 Insert a bootable DOS diskette into drive A and turn on the computer. It should boot from drive A and automatically detect the new drive as a 2.1-Gbyte drive.
- 5 Insert your DiskWizard diskette into drive A and type **A:DM**. Then press **ENTER**. This runs the Disk Manager program.
- 6 Follow the Disk Manager instructions to install the dynamic drive overlay and to partition and format your new drive to its full capacity.
- 7 After Disk Manager is done, reboot your system. You should see the Disk Manager banner and be able to access the full capacity of your new drive.

The screen remains blank when you power up the system.

If the steps listed above do not remedy this problem, try the following:

- 1 Make sure the monitor is plugged in and turned on.
- 2 Check all cards.
- 3 Make sure the video card is seated in its slot and secured with mounting screws.
- 4 Turn off the computer and remove the drive host adapter. If the screen turns on after you reboot, the host adapter may be incompatible or defective. If so, see your dealer.

The system does not recognize the drive.

- 1 Check all cables.
- 2 Make sure the power supply is adequate for system needs.
- 3 Reboot the computer and listen to make sure the drive motor starts up. If the drive is very quiet, it may be difficult to hear its discs reach operating speed. If the drive motor does not start up, recheck all drive cables.
- 4 Verify that for each drive, a drive-type is listed in the system setup program.
- 5 Try rebooting your computer by pressing the **CTRL-ALT-DELETE** keys simultaneously. If the drive is recognized after you reboot the system, the computer BIOS test may be completing before the drive is ready. One solution is to slow the processor speed during startup. If your computer has a turbo switch, set it to slow speed before turning the computer on. If there is no turbo switch, you may be able to use keyboard commands; see your computer manual for details. After the computer is up and running, return the processor to the fast speed. Another solution is to warm-boot your computer after every power-on.

- Check for I/O address conflicts. To isolate the conflict, verify that the drive and host adapter are compatible with your computer. Turn off the computer and remove all the peripheral adapter cards except for the video card and host adapter. If the computer recognizes the drive when you reboot the computer, turn off the computer. Reinstall the other peripheral cards, one at a time, until the conflict recurs. After you have isolated the source of the address conflict, you can resolve the conflict by changing the I/O address of the peripheral that appears to cause the conflict.
- If Disk Manager has installed the DDO on your hard drive and you have booted directly from a diskette, the information in the boot record of the drive may not have been loaded. Make sure there is no diskette in Drive A and reboot. If you want to boot from the diskette, follow the "Booting with a Diskette" instructions under "Advanced Disk Manager Options."

The dealer partitioned and formatted the drive for you in the store, but the drive does not respond when you install it.

- 1 Reboot the computer and make sure the drive spins up. Check all cables.
- 2 Make sure the power supply is adequate for system needs.
- 3 Make sure the DOS version the dealer used to partition and format the drive is the same version you have installed in your computer. If it isn't, see your dealer.
- 4 Verify the drive-type values in the system setup program. You must install the drive using the same drive-type values your dealer used to partition the drive.
- 5 Check for I/O address conflicts between peripheral cards.
- 6 Check for viruses.

The system hangs in FDISK or fails to create or save the partition record.

- 1 Check all cables.
- 2 Your DOS diskette may be corrupted. Try using a backup DOS diskette.
- 3 Make the partitions smaller.
- 4 Change the interrupt/jumper setting on the host adapter.
- 5 Some BIOS have a Track 0 protection feature that protects Track 0 from writing. This may cause FDISK to hang the system. You may disable this feature in the system setup program before you can use FDISK. See your computer reference guide for assistance. Be sure to re-enable this important feature when FDISK is done.

The system error message, "Drive not Ready," appears.

- 1 Check all cable connections. Make sure pin 1 of the drive is connected to pin 1 of the hard-disc controller or host adapter.
- 2 Make sure the power supply is adequate for system needs.
- 3 Reboot the computer and make sure the drive spins up.

The FDISK error message, "No Fixed Disk Present," appears.

- 1 Make sure the power supply is adequate for system needs.
- 2 Verify the drive-type values in the system setup program.
- 3 Check for I/O address conflicts.

The drive does not format to full capacity.

- 1 Verify the drive-type values in the system setup program. One of the following problems may have occurred:
 - The values may be set with an incorrect translation characteristic.
 - You may have entered a parameter value that exceeds the physical capacity of the drive.
 - You entered a translation characteristic that does not take advantage of the drive's full capacity.
 - The drive's physical specifications exceed the translation limits imposed by the BIOS.

- 1 **Caution.** If you change the drive-type values in the system setup program, you must partition and format the drive again. This erases data on the drive.

- If you have partitioned the drive into individual logical drives, you may need to make the partitions smaller to access the full drive capacity.
- If your computer supports LBA mode, you may need to enable LBA mode in the system setup program to access the full capacity of the drive. Refer to your computer's reference guide to find out how to enable LBA.
- Your computer may not support drives that have more than 4,096 cylinders. Follow the instructions for *After you install your new drive, your computer will not boot, and no error message shows on the screen.*

The DOS messages "Disk Boot Failure," "Non-System Disk" or "No ROM Basic - SYSTEM HALTED" appear.

- 1 Install the DOS system files using the DOS SYS utility.
- 2 Check all cables.
- 3 Use FDISK to verify that the primary partition is active.
- 4 Check for viruses.

The system error message, "HDD controller failure" appears.

- 1 Confirm the jumper settings on the drive.
- 2 Verify the drive-type settings in the system setup program.

32-bit Disk Access with Windows 3.1

The 32-bit disk access feature in Windows 3.1 does not work with drives that have capacities greater than 528 Mbytes. If you want to use 32-bit disk access under Windows 3.1, install the Seagate replacement 32-bit access driver, SEG32BIT386, located on your DiskWizard diskette.

BIOS Upgrades

If you need to upgrade your BIOS, contact the appropriate BIOS manufacturer listed below.

American Megatrends (AMT): <http://www.megatrends.com>

1-800-828-9264

Award Software International, Inc.: <http://www.award.com>

1-508-686-6468

MicroR Research/Mr. BIOS: <http://www.mrbios.com>

(Upgrades from Unicore Software) 1-800-800-2167

Phoenix Technologies Ltd.: <http://www.phltd.com>

(Upgrades from Microfirmware) 1-800-767-5465

SystemSoft: <http://www.systemsoft.com>

SEAGATE TECHNICAL SUPPORT SERVICES

If you need assistance installing your drive, consult your dealer. Dealers are familiar with their unique system configurations and can help you with system conflicts and other technical issues. If you need additional assistance with your Seagate drive or other Seagate products, use one of the Seagate technical support services listed below.

SeafONE™ 1-800-SEAGATE

Seagate's 800 number (1-800-722-4283) allows toll-free access to automated self-help services, providing answers to commonly asked questions, troubleshooting tips and specifications for disk drives and tape drives. This service is available 24 hours daily and requires a touch-tone phone. International callers may reach this automated self-help service by dialing 408-456-4496.

Online Services

SeaNET™

You can obtain technical information about Seagate products over the Internet from Seagate's World Wide Web home page (<http://www.seagate.com>) or Seagate's ftp server (<ftp://ftp.seagate.com>). You can also send e-mail with your technical questions to discsupport@seagate.com.

Seagate CompuServe Forum

Online technical support for Seagate products is available on CompuServe. To access our technical support forum, type **go seagate**. This forum provides information similar to that found on Seaboard. In addition, you can type questions or browse through previous questions and answers on the forum messages.

Seaboard™

Seaboard is a computer bulletin board system that contains information about Seagate disc and tape drive products and is available 24 hours daily. Set your communications software to eight data bits, no parity and one stop bit (8-N-1).

Location	Phone number	Location	Phone number
Australia	61-2-9756-2359	Taiwan	886-2-2719-6075
France	33 1-48 25 35 95	Thailand	662-531-8111
Germany	49-89-1430-9331	UK	44-1628-890601
		USA	405-936-1600

FAX Services

SeoFAX™

You can use a touch-tone telephone to access Seagate's automated FAX system to receive technical support information by return FAX. This service is available 24 hours daily.

Location	Phone number	Location	Phone number
Australia	61-2-9756-5170	UK	44-1628-890604
Germany	49-89-1430-5102	USA	405-936-1620

Seagate Technical Support FAX

You can FAX questions or comments to technical support specialists 24 hours daily. Responses are sent during business hours.

Location	Phone number	Location	Phone number
Australia	61-2-9725-4052	Korea	82-2-556-4251/7395
France	33 1-46 04 42 50	Singapore	65-488-7528
Germany	49-89-1430-5100	Taiwan	886-2-2715-2923
Hong Kong	852-2368 7173	UK	44-1628-890660
Japan	81-3-5462-2979	USA	405-936-1685

Direct-Support Services

Seagate Technical Support

For one-on-one help, you can talk to a technical support specialist during local business hours. Before calling, note your system configuration and drive model number (SXXXX).

Location	Phone number	Location	Phone number
Australia	61-2-9725-3366	Singapore	65-488-7584
France	33 1-41 86 10 86	Taiwan	886-2-2514-2237
Germany	49-89-1430-9332	UK	44-1628-894083
Hong Kong	852-2368 9918	USA	1-800-SEAGATE or 405-456-4496
Korea	82-531-5800	USA	405-456-4496

SeatD™

405-936-1687

Using a telecommunications device for the deaf (TDD), you can send questions or comments 24 hours daily and exchange messages with a technical support specialist between 8:00 A.M. to 12:15 P.M. and 1:30 P.M. to 6:00 P.M. (central time) Monday through Friday.

STORING AND SHIPPING YOUR DRIVE

Keep your original box and packing materials for storing or shipping your drive. The box has a Seagate Approved Package label. Shipping a drive in an approved container voids the warranty. Call your authorized Seagate distributor for information on packing materials. The figure to the right shows how a drive fits in an approved single-pack box, including the packing materials.

Warranty. See your authorized Seagate distributor or dealer. Preinstalled or furnished software is provided "as is." There are no warranties of merchantability or fitness for a particular purpose. All such warranties are expressly and specifically disclaimed.

Maintenance and repair. Seagate drives do not require maintenance. The head/disc assembly is sealed; a broken seal voids the warranty. Seagate customer-service centers are the only facilities authorized to repair Seagate drives.

Electromagnetic Compliance for the European Union. This model complies with the European Union requirements of the Electromagnetic Compatibility Directive 89/313/EEC of 23 May 1989 as amended by Directive 92/31/EEC of 28 April 1992 and Directive 93/68/EEC of 22 July 1993. Compliance of this drive, as a system component, was confirmed with a test system. We cannot guarantee that your system will comply. The drive is not meant for external use (without properly designed enclosure, shielded I/O cable, etc.).

Sicherheitsanweisung 1. Das Gerät ist ein Einbaugerät, das für eine maximale Umgebungstemperatur von 55°C vorgesehen ist. Zur Befestigung des Laufwerks werden 4 Schrauben der Größe nicht mehr als 3,3 mm und bei Befestigung an der Unterseite nicht mehr als 1,0 mm benötigt. 3. Alle Versorgungsanschlüsse werden benötigt: +5V ±5%, 0 A; +12V ±5% 0,8 A (1,9 A für ca. 30 Sek. für ±10%). 4. Die Versorgungsspannung muss SELV entsprechen. 5. Alle Arbeiten auf dem Gerät dürfen nur von Auszubildendem/Servicepersonal durchgeführt werden. Bitte entfernen Sie nicht die Abschirmhülle des Laufwerks. 6. Der Einbau des Laufwerks muss den Anforderungen gemäß DIN IEC 950 VDE 0805/50 entsprechen.

Seagate, Seagate Technology, and the Seagate logo are registered trademarks of Seagate Technology, Inc. SeoFAX, SeafONE, Seaboard, SealeT, SeatoD, Medialist, the Medialist logo and DiscWizard are other trademarks or registered trademarks of Seagate Technology, Inc. or one of its subsidiaries. All other trademarks or registered trademarks are the property of their respective owners.

Seagate reserves the right to change, without notice, product offerings or specifications. No part of this publication may be reproduced in any form without written permission from Seagate Technology, Inc.

© 1998 Seagate Technology, Inc.
920 Disc Drive, Scotts Valley, CA 95066, USA
Publication Number: 32660-001, Rev. A, January 1998, Printed in USA