

SAMSUNG

HX-DU010EC
HX-DU015EC
HX-DU020EC

G3 Station External Hard Drive User's manual



Read Me First

About this Manual

Your product comes with a quick installation guide and a user's manual. Following the instructions and precautions of this manual will ensure easier and more enjoyable use of your G3 Station External Hard Drive.

Quick Installation Guide

An installation guide is provided with the purchase of G3 Station External Hard Drive. The Quick Installation Guide explains product components and provides simple instructions on how to install the product.

User's Manual



The User's Manual contains detailed information about features and instructions on using your G3 Station External Hard Drive.

Using this Manual

Carefully read and understand the "Handling Precautions" section before using the product. Failure to follow all the instructions as outlined in the Handling Precautions section could result in damage to you or to your G3 Station External Hard Drive.

- Refer to the Troubleshooting section first if you experience a problem with the product.

Icon Guide

Icon		Meaning
	Precautions	These must be read thoroughly before using any of the functions.
	Caution	This contains must-know information about functions. User must be careful.
	Note	This contains useful information about the functions.

 Software and user manuals are available for download at the Samsung Hard Disk Drive website (www.samsunghdd.com). The content of this User's Manual may change without prior notice for product improvement purposes.

Handling Precautions

The following information serves to ensure user's safety and prevent damage to user's properties. Carefully read the information provided and use your product correctly.

Use the rated Power adapter

Use only the power adapter supplied with the product or approved by Samsung Electronics.

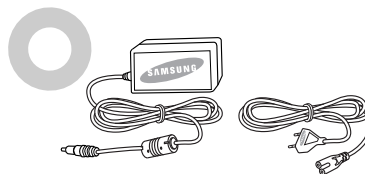

Installation Related

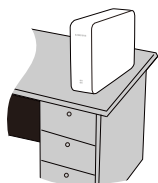

Use the product on a flat surface.

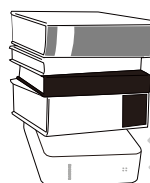

Do not sit on the product and do not place a heavy object over the product.

Product case or connector can be damaged and may cause a break down.

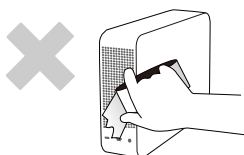

Avoid blocking the vent at the bottom or side of the external drive.

If the vent is blocked, there is a danger of damaging the external drive or overheating the inside of the product.

Power Related

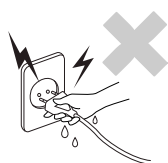

Do not touch the main plug or power cord with hands.

There is a danger of electric shock.

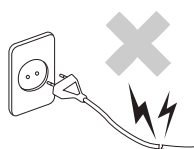

Do not use a damaged or loose main plug or power cord or power outlet.

There is a danger of electric shock or fire hazard.

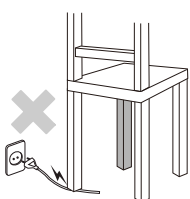

Do not bend the power cord excessively or do not place a heavy object over the power cord.

If the power cord is damaged, it may cause electric shock or fire and may increase the wrong operation.

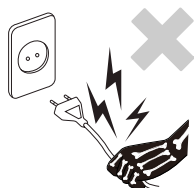

Do not unplug the power cord out by pulling the cable only.

If the power cord is damaged, it may cause electric shock.

Data Cable Usage

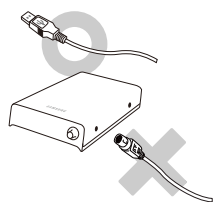

Standardized data cable.

This may increase the wrong operation and may cause a malfunction.

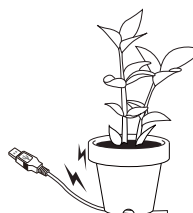

Do not severely bend the data cable and do not place a heavy object over the data cable.

If the data cable is damaged, it may cause a malfunction.

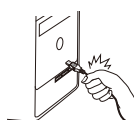

Do not unplug the data cable by severely pulling the cable.

This may damage connector on the product and may cause a problem with the product.

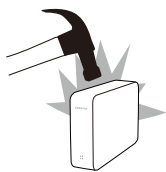

Shock

The External Hard Drive is very portable and you may easily drop it. Take care not to drop and tip the product while carrying the External Hard Drive. If you make an impact on the external drive, it may cause bad sectors on the disk. Bad sectors can cause various and potentially read/write errors.

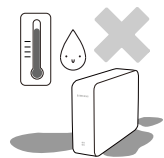

Humidity

If you use the product in places exposed to humidity, it may danger of electric shock. In addition, prolonged exposure to moisture can corrode various parts and components.

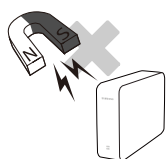

Magnets

Magnetic objects can cause various types of damage to the External Hard Drive, including data damage. Keep magnets and magnetic objects away from the External Hard Drive.

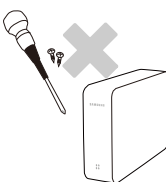

Disassembly and Label Removal

For repair, please visit the designated (samsung) customer service center. Unauthorized disassembly, repair, or reform of the product and unauthorized removal of the labeling will void your warranty.

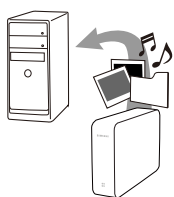

Always Backup your Important Data

The External Hard Drive manufacturer does not guarantee data stored in the External Hard Drive and will not assume responsibility for any mental or material damage incurred during data recovery.

- Backup : Storing the original and a copy on two or more separate and accessible storage media.

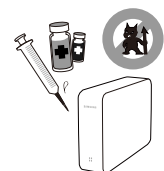

Regular Virus Scanning

Frequently scan the device for viruses and protect the external drive from virus infection.

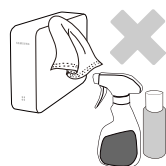

Cleaning the product

Never use cleaning fluid or similar chemicals. Do not spray cleaner directly on the product. It may cause discoloration and deformation of the product.



Custody Related

Keep the product and accessories out of the reach of children. It may cause personal injuries and problem.

Safely Remove Hardware

Always use the Safely Remove Hardware feature before shutting down the External Hard Drive or disconnecting the USB cable and power cable.

1MB=1,000,000bytes / 1GB=1,000,000,000bytes / 1TB=1,000,000,000,000bytes

Actual accessible capacity may vary from advertised capacity due to formatting and partitioning of the hard drive, as well as due to your computer's operating system.

Table of Contents

Read Me First	2	About this Manual
	2	Quick Installation Guide
	2	User's Manual
	2	Using this Manual
	2	Icon Guide
Handling Precautionst	3	Use the reted Power adapter
	3	Installation Related
	3	Power Related
	3	Data Cable Usage
	4	Shock
	4	Humidity
	4	Magnets
	4	Disassembly and Label Removal
	4	Always Backup your Important Data
	4	Regular Virus Scanning
	4	Cleaning the product
	4	Custody Related
	4	Safely Remove Hardware
Specifications	6	System Requirements
	7	Components
	7	Overview
Connecting your G3 Station	8	Installation
	9	Windows
	10	Macintosh
Using your G3 Station	11	Copying / Moving Files
	11	Removable Disk Method
	13	Safely Removing your G3 Station
	13	For Windows
	14	For Macintosh
G3 Station Software	15	G3 Station External Hard Drive Software
	15	Samsung Auto Backup
	15	Samsung Auto Backup Installation
	17	Data Backup using Samsung Auto Backup
	23	Quick Backup
	24	Restoring Backup Data
	27	Samsung SecretZone™
	28	Virtual Drive with Samsung SecretZone™
Troubleshooting	30	FAQ
Appendix	31	Partitioning and Changing File System Type
	31	Reformat to FAT32
	32	Reformat to NTFS
	32	Format in Macintosh
	33	Product Certifications
	33	FCC
	34	Warranty Information

Introduction

The G3 Station External Hard Drive is a high-performance External Hard Disk that supports USB 2.0. Unlike conventional desktop disk drives, the G3 Station External Hard Drive makes it possible for you to instantaneously add greater storage capacity to your system without having to take the computer apart.

This means that your G3 Station External Hard Drive comes fully partitioned and formatted for your use and you can instantly access to the drive by simply plugging it into your computer through a USB port. Rebooting and other cumbersome steps are not necessary.

SecretZone™, which is part of the software bundle that comes with your G3 Station External Hard Drive, allows you to protect and manage your private data.

Specifications

Category	Specification
Interface	USB 2.0
Transfer Rate	480 Mbps Max.
Power	DC +12V, 2.0A
Operating System	Windows XP / Vista / 7
	Mac OS X 10.4.8 or Later
Hard Disk Capacity	1TB / 1.5TB / 2TB
Dimensions (W x H x L)	119.5mm X 41.85mm X 192.8mm
Color	Cobalt Black / Silver White
Format System	NTFS

System Requirements

- PC : Windows XP / Vista / 7
- Macintosh : Mac OS X 10.4.8 or Later
- Upgrade your operating system to the latest version to enjoy better performance and reliability.

Components

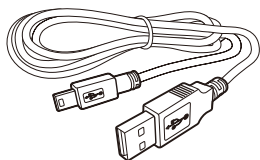

USB Cable

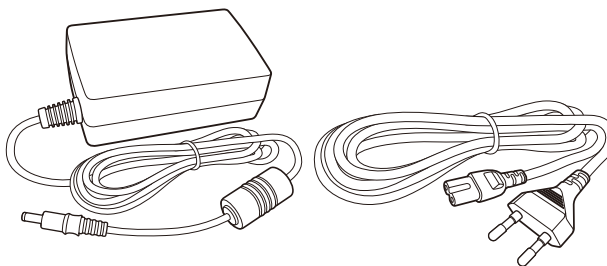

Power Adapter

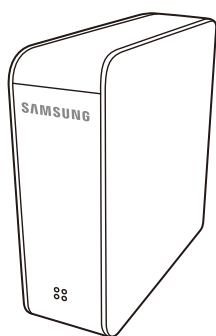

Samsung G3 Station External Hard Drive

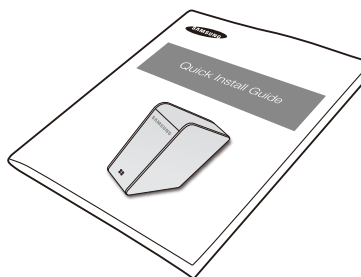

Installation Guide

※ When you purchase a G3 Station External Hard Drive, make sure that all components have been included in your product package.

Overview

There are ports to connect various cables including USB on the backside of G3 Station

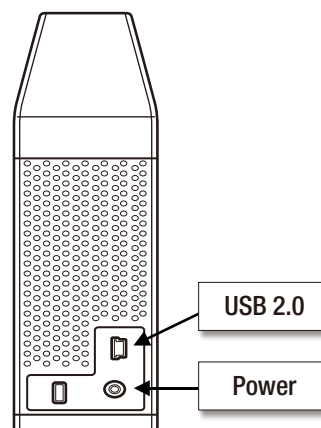
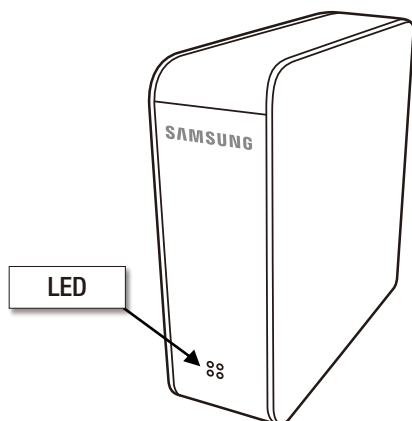

LED Description

- 1) Standby Status : Steadily lit LED
- 2) Read / Write in Progress : Blinking LED

Connecting your G3 Station

Installation

Verify that the computer meets the minimum system requirements as outlined in #System Requirements.

Insert the USB cable to the desktop/laptop computer as shown in Figures 1 and 2:

● Figure 1. Connecting a G3 Station

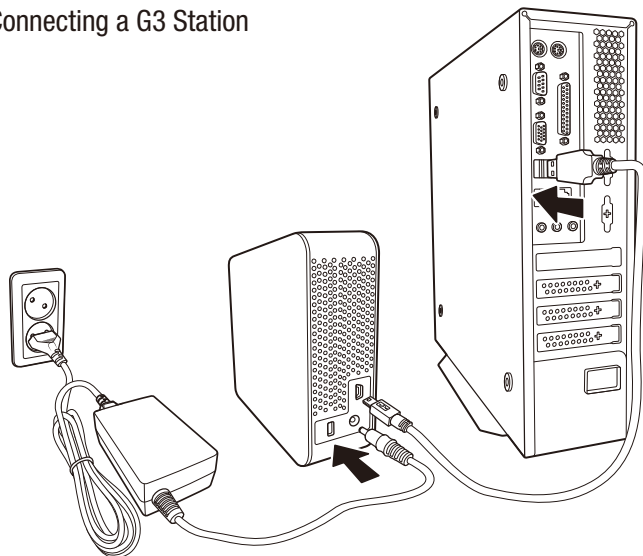

! G3 Station will not power on when the USB Cable disconnected.

■ Plug in the power adapter and connect the USB cable to the corresponding port on your desktop PC or notebook PC.

● Figure 2. Power on a G3 Station

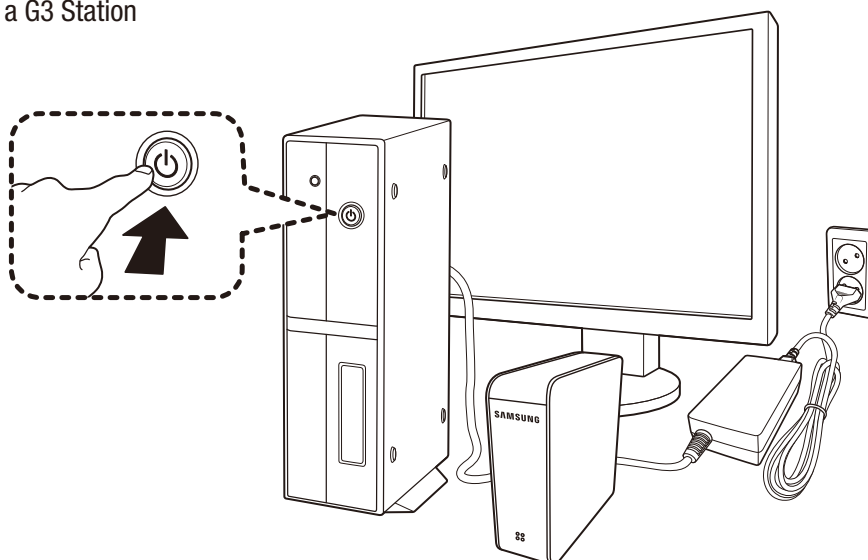

■ Turn the power on your drive with power dial.
Now you can enjoy your drive.

➤ Your G3 Station External Hard Drive will automatically activate once connected to the computer.

Windows

When you connect the G3 Station External Hard Drive to the computer a device icon will appear in the system tray at the lower right corner of the screen.

- Figure 3. System Tray indicating an external device



The operating system will recognize and display "Samsung" drive under "My Computer."

- Figure 4. In the Windows Explorer, you will see a new Samsung drive

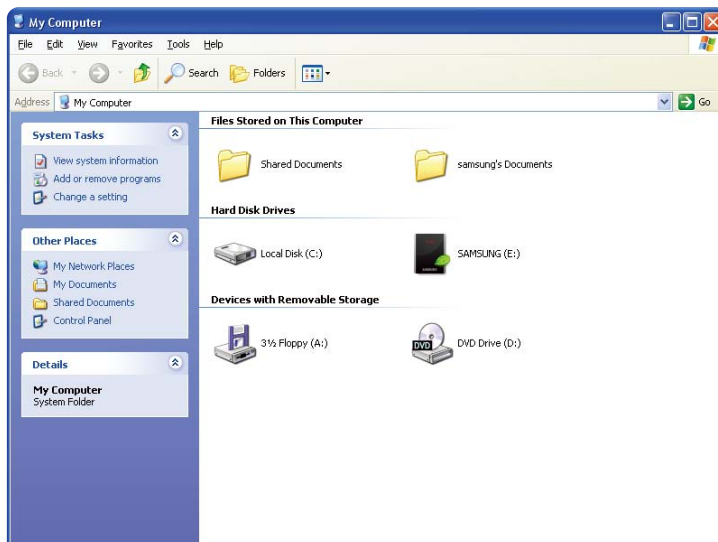

You are now ready to use the Samsung G3 Station External Hard Drive.

Macintosh

Connect your G3 Station External Hard Drive to the computer.
Your Macintosh operating system will then generate a SAMSUNG.

- Figure 5. Macintosh External Hard Drive connection icon



After clicking the SAMSUNG icon, the following folder will appear.

- Figure 6. Macintosh Folders

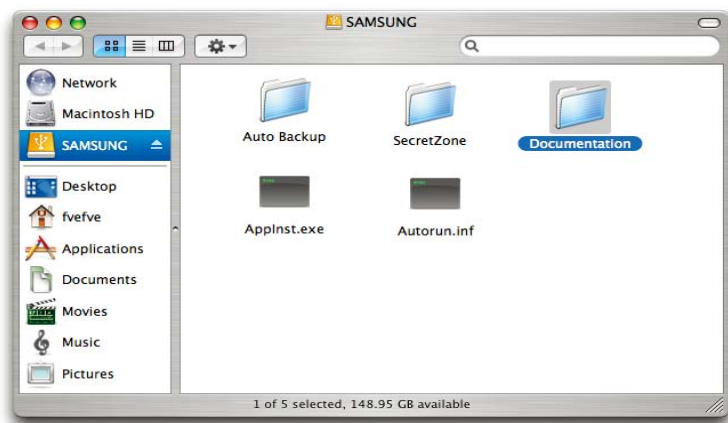

You are now ready to use the Samsung G3 Station External Hard Drive.

 Samsung provides Samsung NTFS 3G driver which can be used to write data on NTFS-format External Hard Drives on Mac OS. Samsung NTFS 3G driver can be downloaded from the Samsung website. (<http://www.samsunghdd.com> → Support → Download → External HDD)

Using your G3 Station

Copying / Moving Files

Now that you have successfully installed your new G3 Station External Hard Drive, you copy or move files or whole folders from your new G3 Station to your computer and vice-versa.



It is important to understand the difference between Copy and Move.

Copy : is to make a duplicate folder or file and store it so that you have two copies.

Move : is to take a folder or file from one location and put it into another.

WHEN YOU MOVE A FOLDER OR FILE, YOU NO LONGER HAVE A BACKUP COPY.

Copy and paste files from the computer to the G3 Station External Hard Drive (Removable Disk Method).

Removable Disk Method

For the purposes of this manual, we will make a copy of the Temp folder on the C drive of your computer and copy it to the G3 Station External Hard Drive.

From the Windows Desktop click:

Start → Programs → Accessories → Windows Explorer

- Figure 7. Getting to the Windows Explorer

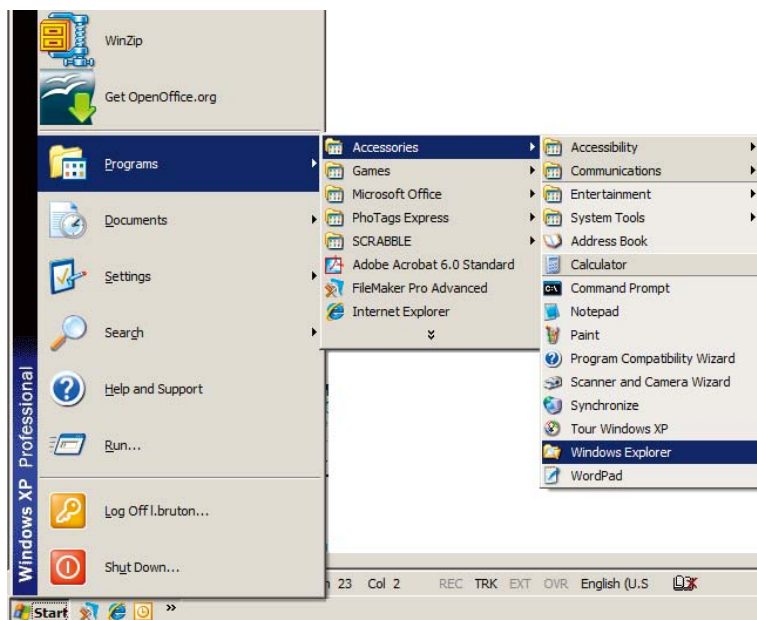

From the Windows Explorer, you will see various drive letters; A, C, your C drive is your local Hard Disk Drive. The G3 Station Drive will most likely be the E drive however, it could be any drive letter. For the purposes of this manual, we will assume that the G3 Station drive is the E drive. As well, for practice copying folders and files, we will copy the Temp folder onto the G3 Station drive.

From the Windows Explorer screen:
 Click Local Disk C
 From the right-hand pane:
 Right-click the Temp folder → Click Copy

- Figure 8. When you Right-Click on a file or folder, you get another menu.

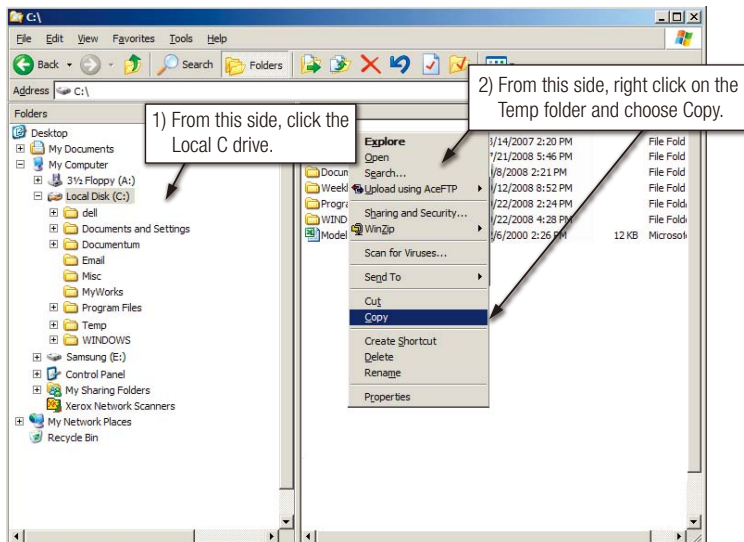

Now, we will copy the Temp folder from the Local C drive, to the Samsung E drive. From the left pane in the Windows Explorer : Right Click Samsung E → Click Paste

- Figure 9. Using a Right-Click again, we can paste the Temp file onto the G3 Station drive.

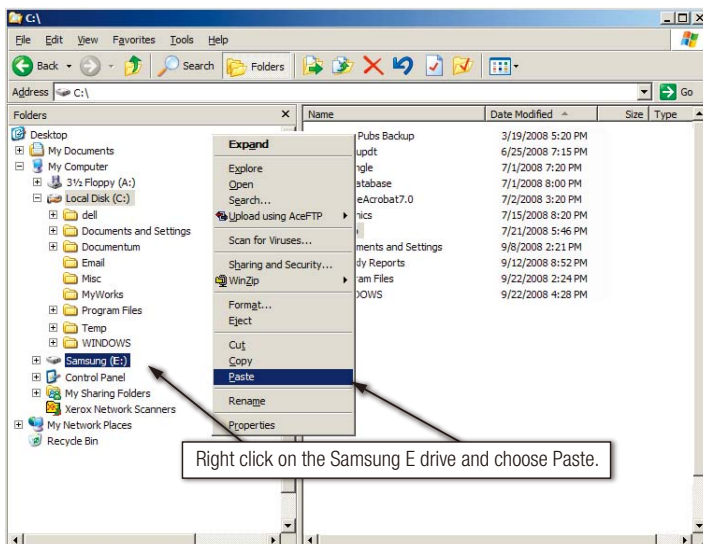

NOTE : Detaching the USB cable while file transfer is in progress can damage your computer and/or G3 Station External Hard Drive. If you need to disconnect the USB cable, wait for the transfer process to complete first and then disconnect using the “Safely Remove Hardware” option.

Safely Removing your G3 Station

For Windows

Right-click the device icon from the system tray at the lower right corner of your screen.

- Figure 10. The taskbar is located at the bottom-right of the screen.



Click "Safely Remove Hardware."

- Figure 11. The "Safely Remove Hardware" prompt will list every device that is attached to your system.



Click "Samsung G3 Station USB Device"

- Figure 12. This prompt will list all of the Mass Storage Devices like your Local Hard drive and your G3 Station Hard drive



When you see the "Safely Remove Hardware" message, you may safely remove the device from the system.

For Macintosh

Click the External Hard Drive icon and select [Eject "SAMSUNG."]

- Figure 13. For the Macintosh click the USB icon and choose Eject "SAMSUNG"



This safely disconnects the drive. It is now safe to detach the drive from the computer.

- ! Do not disconnect G3 Station External Hard Drive's USB cable from the computer while file transfer is in progress. Interrupting the file transfer could lead to data corruption and / or damage to your G3 Station External Hard Drive.

G3 Station Software

G3 Station External Hard Drive Software

Samsung G3 Station External Hard Drive comes with Samsung Auto Backup and Samsung SecretZone™. These applications support the Windows only.

Connecting your G3 Station External Hard Drive to the computer will automatically activate the installation wizard. Select “Run Program” to install the applications.

Samsung Auto Backup and Samsung SecretZone™ will only be available when G3 Station External Hard Drive is connected to your computer.

For further information, please refer to the Auto Backup and SecretZone™ user's manuals that accompanied your G3 Station External Hard Drive.

Samsung Auto Backup

Samsung Auto Backup is a personal backup solution that enables you to backup individual files. The application provides both manual and automatic (scheduled) backup features and includes various backup options such as backup in compressed file format and use of filters for backup files.

Samsung Auto Backup Installation



1. You will see this dialog the first time you connect your G3 Station External Hard Drive to the computer.
2. Select “Install Samsung Tools” and the click “OK.”



When you install the samsung bundle software on the windows 7, you should run the “Applnst.exe” manually in Samsung External Hard Drive. The Windows 7 does not support the Autorun function.



3. Select “Install Samsung Auto Backup” to start the installation process.

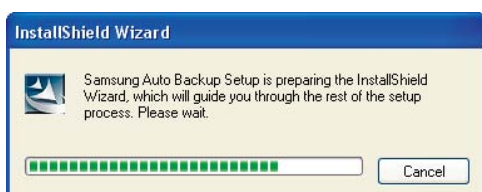

4. Once the preparation process is complete, InstallShield Wizards' greeting dialog will display.



5. Click "Next."

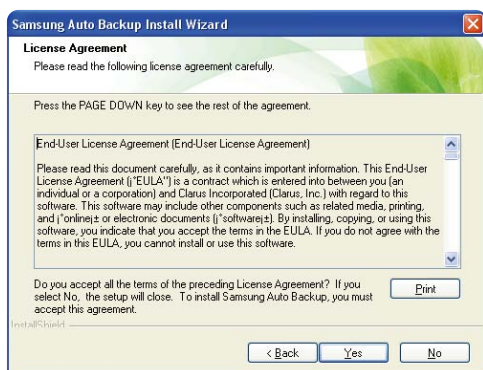

6. The dialog will display the end user license agreement. Carefully read the agreement. Select "Yes".

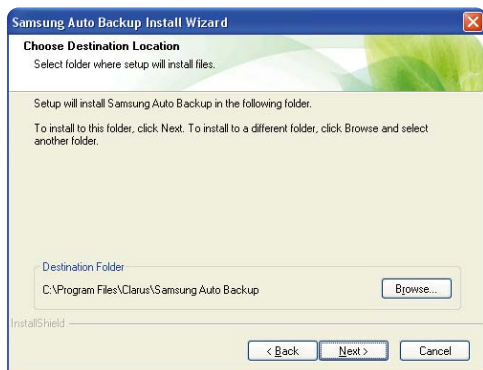

7. Select the destination for Samsung Auto Backup installation and then click "Next."

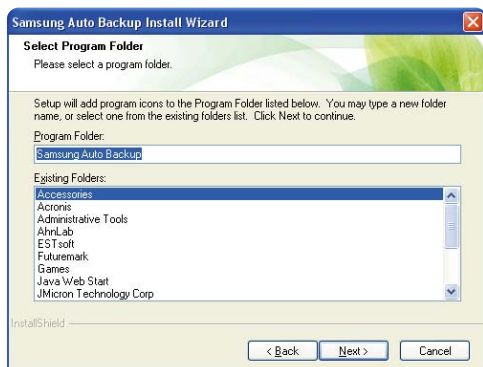

8. Select the folder under which you wish the Samsung Auto Backup icon to be registered. Then, click "Next."

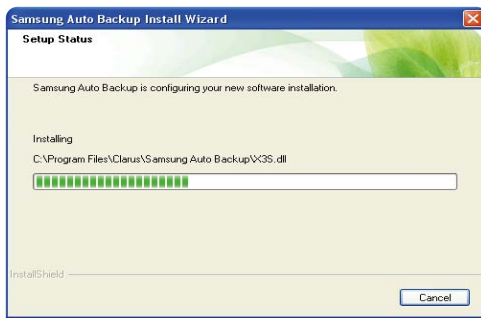

9. The dialog will then display the installation progress.



10. Once the installation process is complete, a dialog requesting your decision on whether to reboot now or later will prompt. Click "Finish" to exit the installation wizard.

Select "Yes, I want to restart my computer now" and then exit the installation wizard in order to finalize Samsung Auto Backup installation.

Data Backup using Samsung Auto Backup

There are two ways to backup data:

- Data Backup Options
- Manual Backup
- Quick Backup

You will need to first configure backup options before using Samsung Auto Backup.

Launch Samsung Auto Backup by clicking Start → Programs → Samsung → Samsung Auto Backup.

- Figure 14. Samsung Auto Back Screen

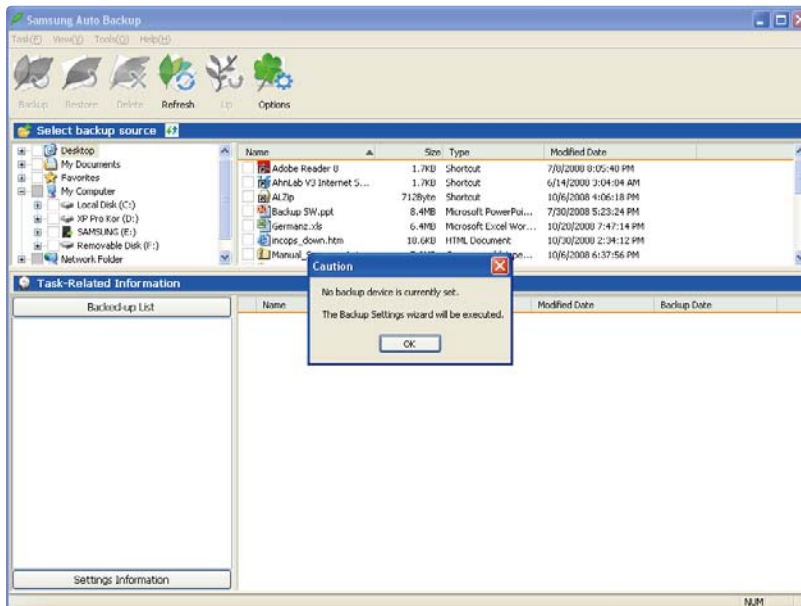

- Figure 15. Backup Destination Selection Dialog



Designate the path to the backup device and then click "Next."

- Figure 16. Optional Settings Dialog

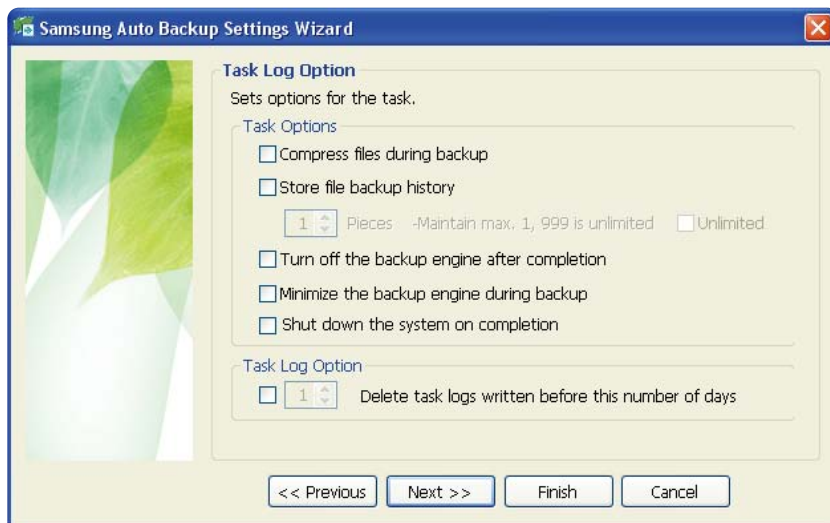

Configure the various backup options.

- Figure 17. File Filter Configuration Dialog

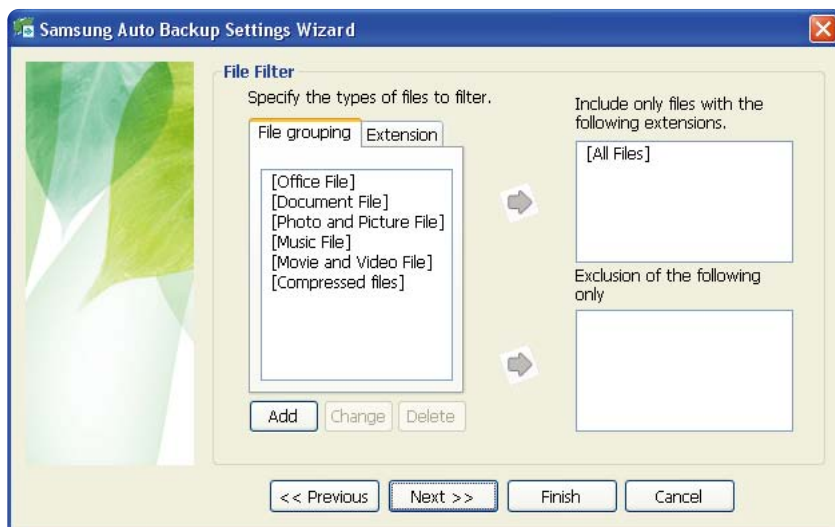

From the File Filter Configuration dialog, you will be able to select types of files you wish to backup and you wish to be excluded from the backup process.

You can define these files by grouping or by specific file extensions. For file groups, the application provides preconfigured groups and the ability to add user-defined groups.

Clicking "Next" without making any change in this dialog sets the application to backup all types of files from the source.

- Figure 18. Backup Scheduling Dialog

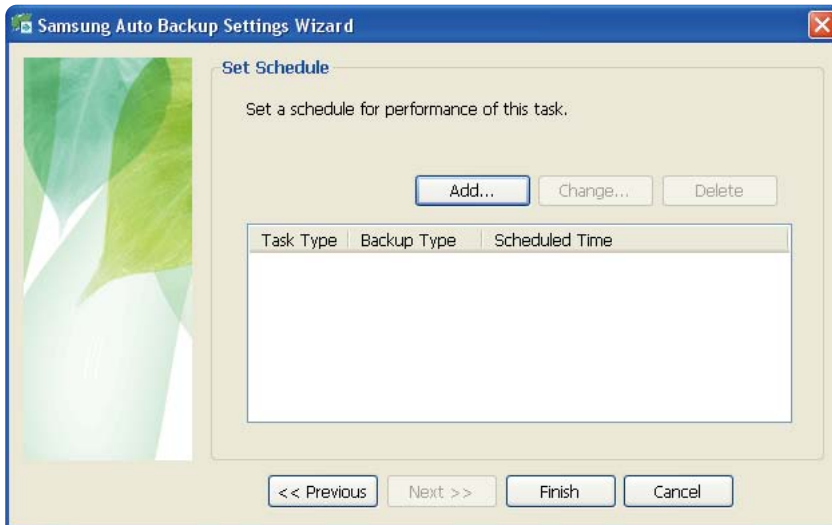

It's even possible for the user to schedule automatic backups. Click "Add" to configure and add a new Auto Backup schedule. Clicking the "Add" button will prompt the New Schedule dialog.

- Figure 19. New Schedule Dialog

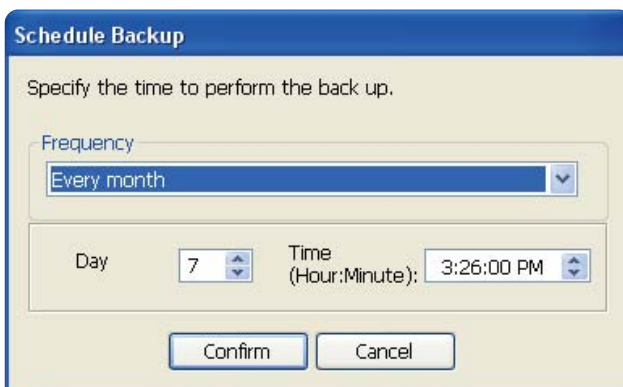

Select how often and when you wish Auto Backup to be performed and click "OK."

From the Backup Scheduling dialog, click "Finish" to exit the backup configuration wizard. You are now ready to backup your data.

Samsung Auto Backup is configured to perform real time backup by default. Therefore, the application will automatically back up the content of "My Documents" after you exit the backup configuration wizard.

● Figure 20. Initial Application Screen

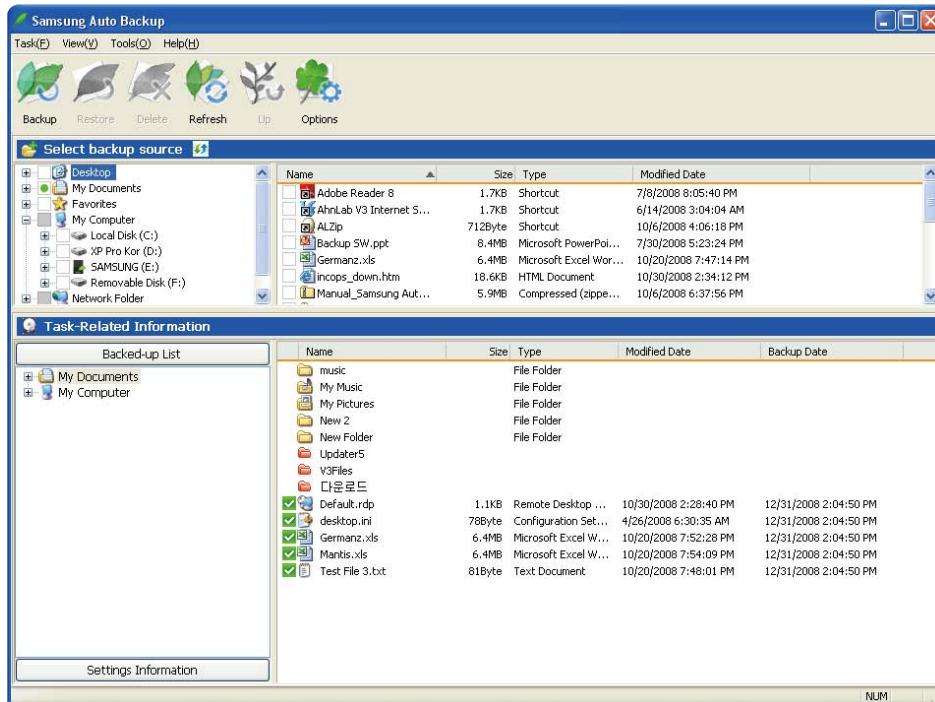

Once you have successfully configured Auto Backup, a new icon will appear on your system tray.

In this icon, the red section of the bar indicates the amount of storage device space used and the green section indicates the amount of space available.

● Figure 21. System Tray



Double-click the icon to view detailed information about the device's space use.

● Figure 22. Device Information Screen

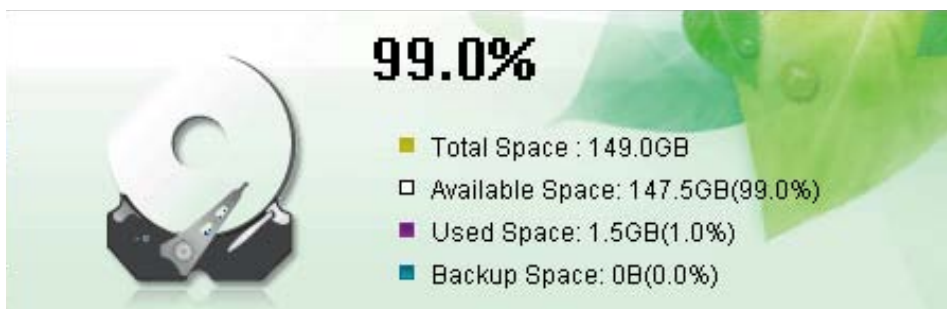

Select original file(s) you wish to back up by checking the file(s) and/or folder(s) from the Original File Selection window.

● Figure 23. Original File Selection Screen – Manual Backup

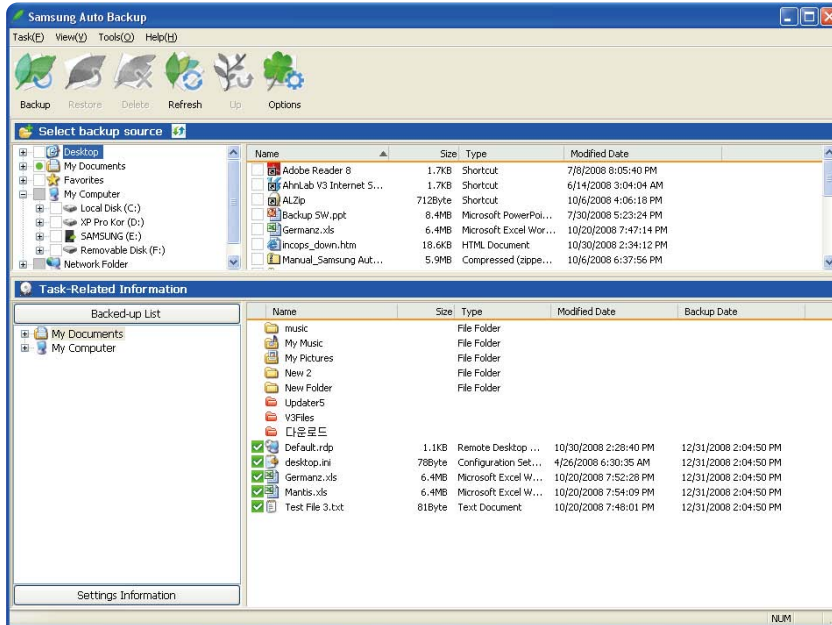

Select “Backup” from the “Task” menu or click “Backup” from the toolbar.

● Figure 24. Backup Completion Dialog

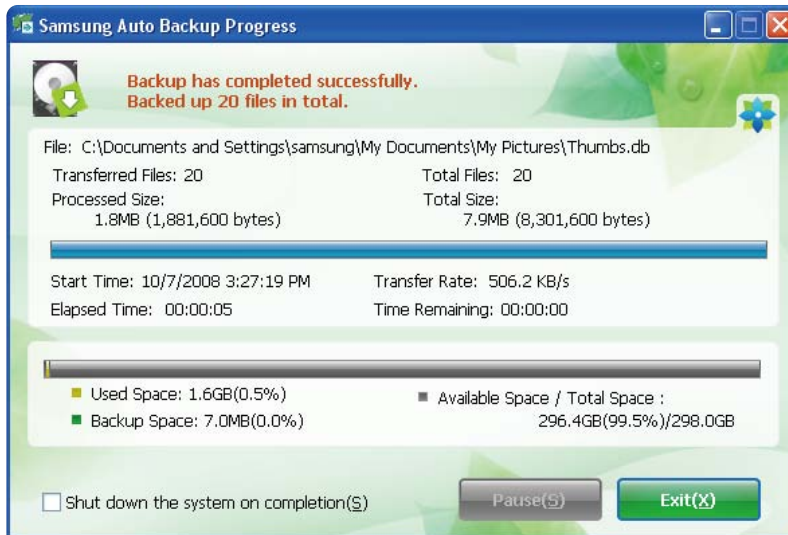

Quick Backup

Select file(s) and/or folder(s) you wish to back up. Right-click on your selection and then select "Quick Backup" from the context menu.

- Figure 25. Original File Selection Screen – Quick Backup

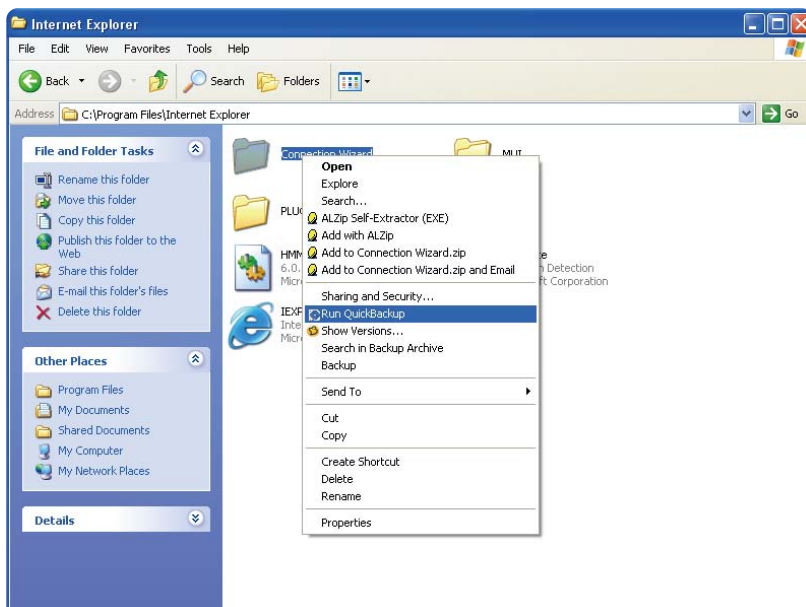

- Figure 26. Backup Completion Dialog

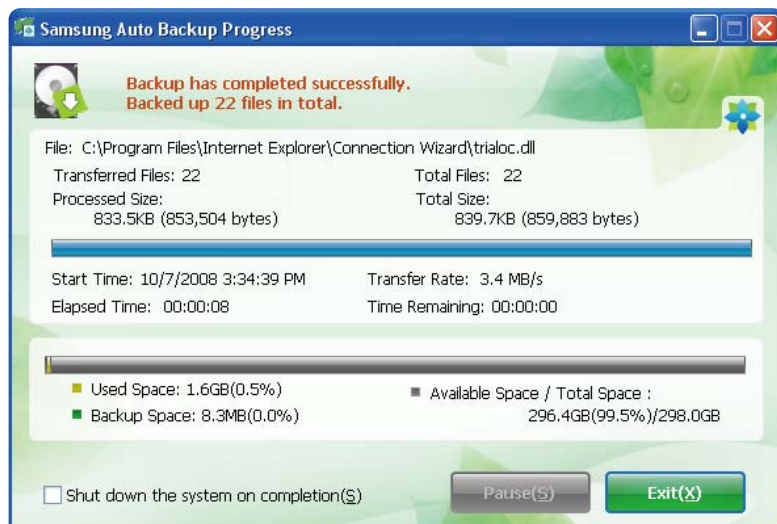

! Quick Backup will only function with the backup device properly configured. Files and folder that have been backed up with Quick Backup are automatically stored as backups of originals.

Restoring Backup Data

You can restore your backup data using Samsung Auto Backup.

To restore your backup data using Samsung Auto Backup, you will need to launch the restore wizard. There are three ways of doing this. First, select the file(s) and/or folder(s) you wish to restore and:

Right-click on selected files and select "Restore."
 Select "Restore" from the "Task" menu.
 Click on "Restore" from the toolbar.

● Figure 27. Restore Selection Screen

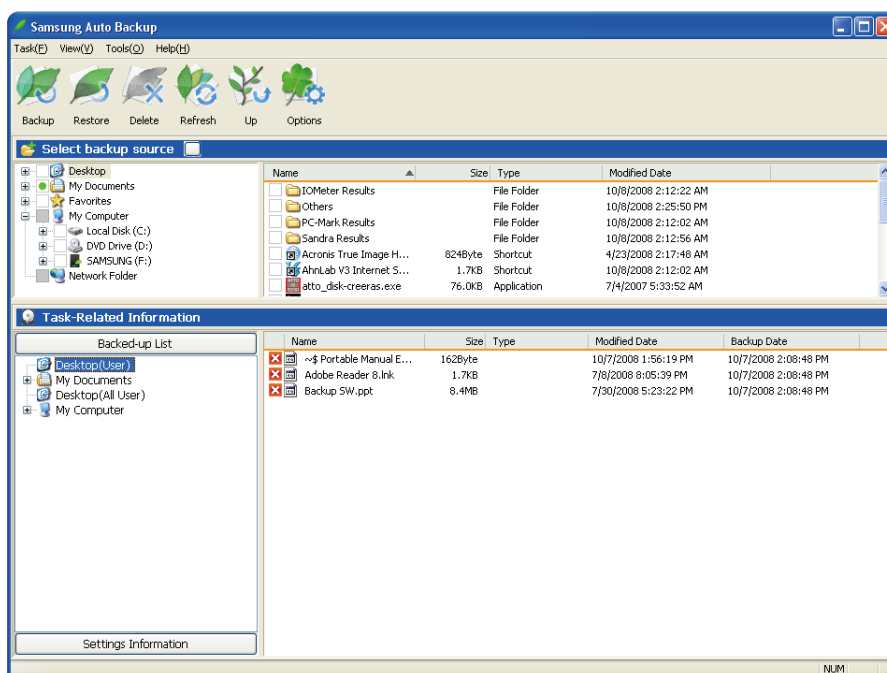

- Figure 28. Restore Destination Selection Screen

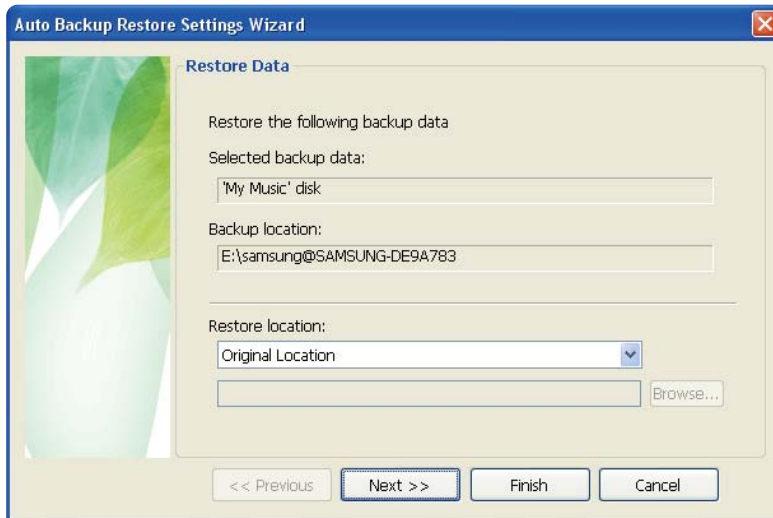

Restore wizard's first screen will prompt you to select the restore backup file destination. There are two options available to you, which are:
 Restore backup files to their original folder or
 Designate a new destination folder to restore backup files to.

- Figure 29. Restore Options Screen

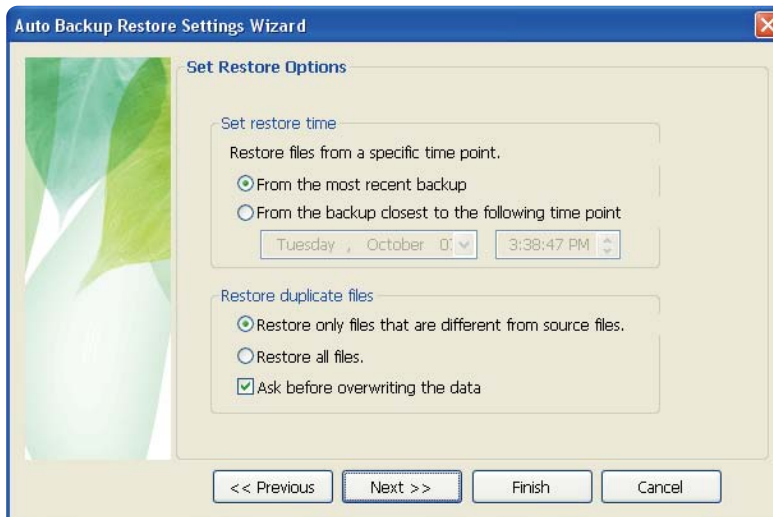

Restore wizard will then present restore time and duplicate file restoring options. You will be able to choose to restore backup files from the most recent backup or from the closest backup to a specified date and time. As for duplicate backup files, you have the option to restore backup files that are different from their originals only or to restore all the files.

- Figure 30. File Filter Screen

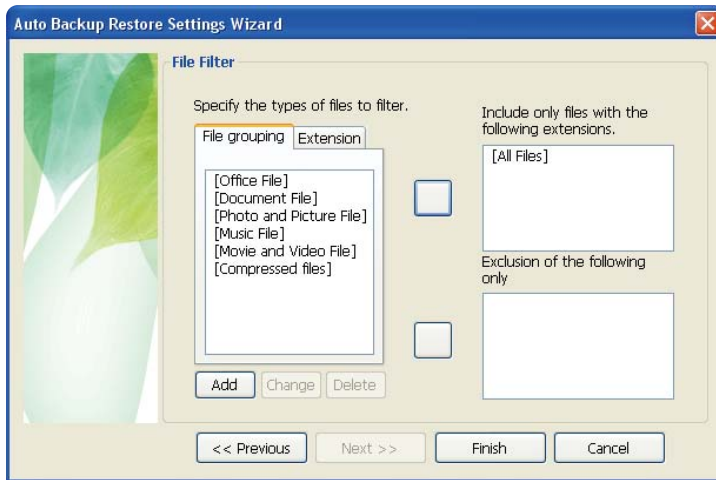

Restore file filter wizard lets you designate the types of files you wish to restore. Designate the types of file extensions and/or file groups you wish to restore or exclude from restoring and then click “Finish.” Clicking “Finish” without making any change in this dialog sets the application to restore all file types.

After configuring the options, click “Finish” to start restoring backup files. Samsung Auto Backup Engine window will prompt and display the restore progress. This engine ignores duplicate files and restores only those files with different data or creation date, resulting in much faster processing times.

Once the process is complete, the following screen will display:

- Figure 31. Restore Completion Screen

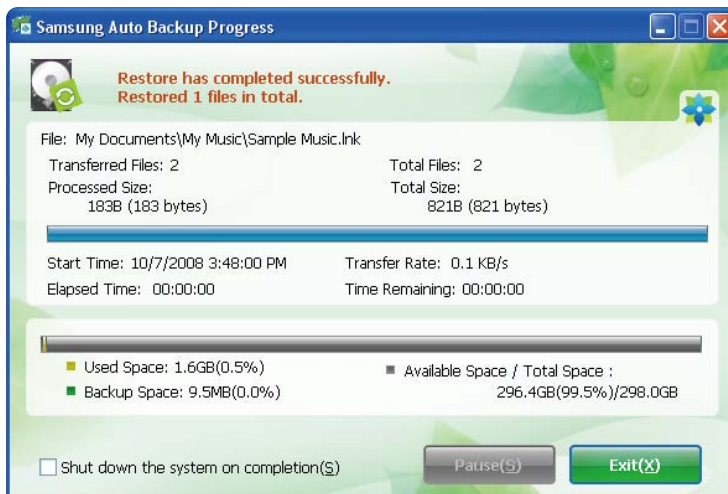

Samsung SecretZone™

Samsung SecretZone™ is an information privacy software application operating in the Windows environment. Samsung SecretZone™ enables you to save and protect important and private data from others with ease.

Samsung SecretZone™ Installation



1. You will see the following dialog the first time you connect your G3 Station External Hard Drive to the computer.

2. Select "Install Samsung Tools" and then click "OK."



Stop & Read

When you install the Samsung bundle software on the Windows 7, you should run the "Applnst.exe" manually in Samsung External Hard Drive. The Windows 7 does not support the Autorun function.



3. Select "Install Samsung SecretZone™".

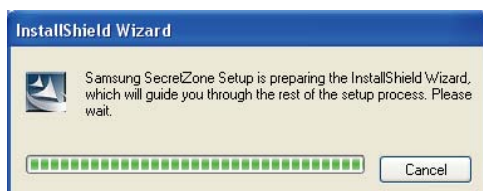

4. Once the preparation process is complete, InstallShield Wizard's greeting dialog will display.



5. Click "Next."

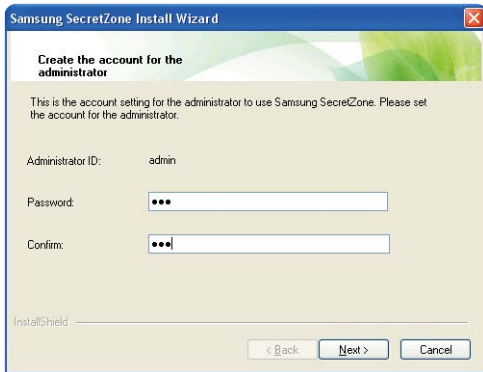

6. You will then be asked to enter an administrator password. Enter the password and then click "Next" to continue.

! Samsung SecretZone™ is a security software and will not allow you access to protected data without a proper ID and password. Be careful not to lose your ID and password.



7. Click "Finish" to complete the installation process.

Virtual Drive with Samsung SecretZone™

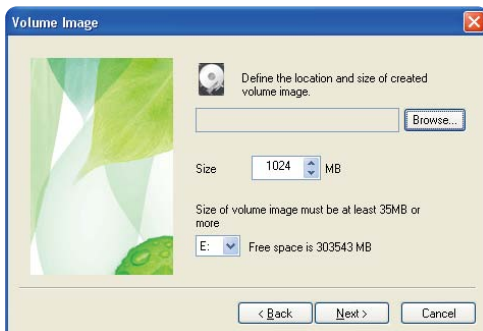

1. If select "Creation" of "File" menu or "Creation" icon of icon bar, Volume Image Creation Wizard will be displayed.

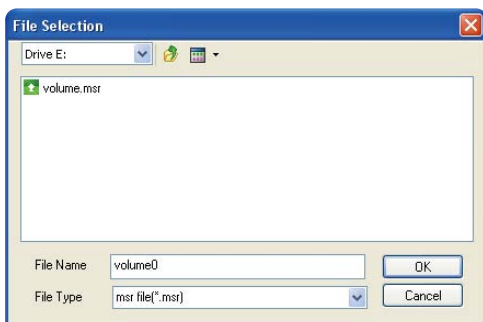

2. Click "Browse" and designate the file you wish to create.

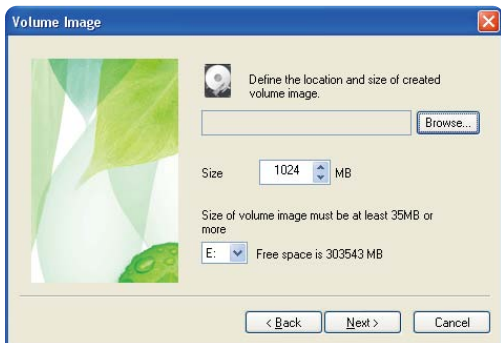

3. Designate the size of the volume image you wish to create.

! Software limitations require that when using a FAT32 file system the maximum volume image size is 2 gigabytes. Using the NTFS file system allows for a volume image size of up to 2 terabytes

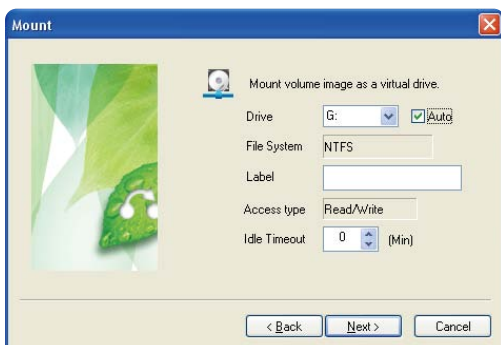

4. Designate the drive to connect with, the file system, label, accessibility, and idle session limit.



5. Designate the volume's password and algorithm.

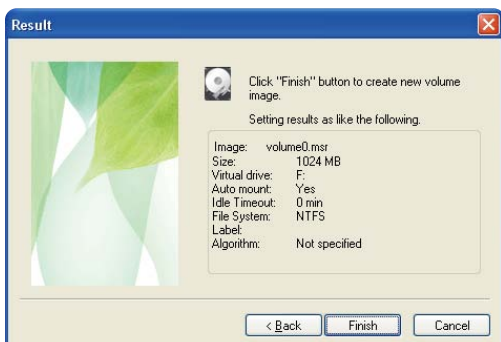

6. Verify your virtual image settings.

7. If the settings are correct, click "Finish" to generate the volume image.

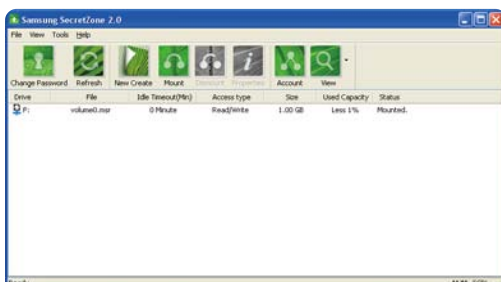

You've now created a virtual drive.

Troubleshooting

- Check the USB cable connection.
- Check the LED light on the External Hard Drive.
- Check the power supply to G3 Station External Hard Drive.
 - Ticking noise is an indication of insufficient power.
- If the drive is not being recognized, try plugging it into a different USB port.

FAQ

Q1. File transfer takes too long.

A1. You will experience slow file transfer speeds if your computer does not support USB 2.0 or if you do not connect G3 Station External Hard Drive to a USB 2.0 port. Try connecting G3 Station External Hard Drive to a different port or, if your computer does not support USB 2.0, purchase a separate USB 2.0 port.

Q2. The actual storage capacity of G3 Station External Hard Drive is different than the capacity shown on the packaging.

A2. Type of file system used for the drive, partitioning arrangement, type of operating system, and various other factors can affect the actual storage capacity displayed by your computer.
(1MB=1,000,000bytes and 1GB=1,000,000,000bytes. 1TB=1,000,000,000,000bytes)

Q3. I connected my G3 Station External Hard Drive, and the computer seems to recognize it, but the drive won't show up under Windows Explorer.

A3. G3 Station External Hard Drive is by default formatted to NTFS and will work normally when you connect it to your computer. However, if the partition has been erased or the file system has been changed to a one that's not recognized by Windows, the drive will not appear under Windows Explorer. Try formatting the drive to FAT32 or NTFS.
(Caution: Formatting will erase all data stored in the drive.)

Q4. I am using Windows XP and cannot format the drive to FAT32.

A4. Windows operating systems that followed Windows NT have limited FAT32 formatting to 32GB. Therefore, if you wish to format your G3 Station External Hard Drive to FAT32, you will need to download a format utility from our website.
(Caution: Formatting will erase all data stored in the drive. We recommend that you back up your data before proceeding.)

Q5. My computer will not boot up properly.

A5. If you boot up your system with G3 Station External Hard Drive connected to the computer, it's possible that your system's BIOS is attempting to boot from the External Hard Drive. Change the BIOS booting sequence or disconnect the External Hard Drive from the system and then try booting again.

Q6. I formatted my G3 Station External Hard Drive and lost all the bundle software.

A6. Bundle applications that came with your G3 Station External Hard Drive are available for download at Samsung Electronics' customer support website.

Q7. I am using a Mac, and I can't copy files.

A7. If the drive has been formatted to NTFS, data stored in the drive can only be read by Mac systems.
To use the drive on Mac OS X operating systems, use Samsung NTFS 3G Driver or reformat your drive.
Samsung NTFS 3G driver : (Refer to the 10 page) Reformat : (Refer to the 31, 32 page)

Q8. What is the maximum settable size for a security zone?

A8. The FAT32 file system limits the size of any file on the drive to a maximum of 4GB. To ensure reliable operation under FAT32, SecretZone™ limits each virtual drive's size to a maximum of 2GB. Windows PC owners who wish to utilize capacity greater than 2GB should re-format their external drive to NTFS in the Windows operating system.

Appendix

! WARNING – PARTITIONING AND FORMATTING YOUR DRIVE WILL PERMANENTLY ERASE ALL THE FILES ON THE DRIVE. DO NOT ATTEMPT TO DO THIS UNLESS ALL OF YOUR FILES HAVE BEEN BACKED UP AND CHECKED FOR RELIABILITY AND READABILITY.

Partitioning and Changing File System Type

It's possible to partition your G3 Station External Hard Drive and change the file system type.

- Reformat to FAT32
- Reformat to NTFS
- Reformat in Macintosh

Reformat to FAT32

- Use Samsung USB Format Utility to format your G3 Station External Hard Drive to FAT32. (Samsung USB Format Utility is a Windows application and is available for download from Samsung's online Customer Support page.)

- Figure 32. FAT format utility page



Reformat to NTFS

Following describes formatting to NTFS in Windows XP:

- Connect G3 Station External Hard Drive to the computer.
- Click “Start” from the lower left corner of your screen.
- Right-click “My Computer” and then select “Manage.”
- From the “Computer Management” tool, select “Disk Management.”
- Right-click the drive you wish to format and then select “Delete Partition.”
- Once drive partition has been deleted, right-click the drive you wish to format and then select “New Partition” as shown in the diagram below.
- From Create Partition Wizard, select “Primary Partition” and then enter the desired size of the partition.
- From the “File System” menu, select “NTFS” and format



WARNING – PARTITIONING AND FORMATTING YOUR DRIVE WILL PERMANENTLY ERASE ALL THE FILES ON THE DRIVE. DO NOT ATTEMPT TO DO THIS UNLESS ALL OF YOUR FILES HAVE BEEN BACKED UP AND CHECKED FOR RELIABILITY AND READABILITY.

Format in Macintosh

Following describes formatting in Mac OS X:

- Launch Mac OS X's “Disk Utility” tool.
- Open the main drive folder from the desktop. Open the “Applications” folder and then the “Utilities” folder.
- Select the “Disk Utility” file.
- Select the drive you wish to reformat.
- Select the “Erase” menu.
- Select “Mac OS Extended (Journaled)” from “Volume Format” menu and then Click “Erase” button

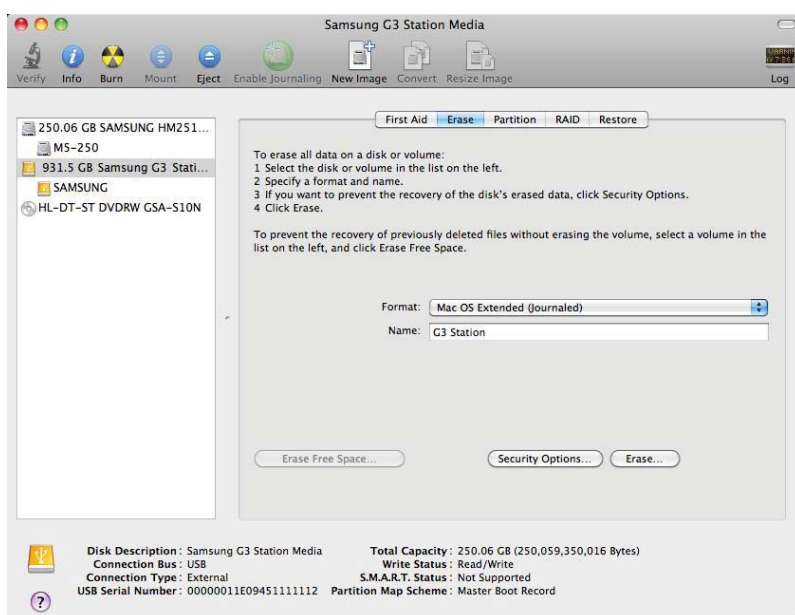

Once formatting is complete, the drive will appear on your desktop.

Product Certifications

- CE** (European Union/Community)
- VCCI** (Voluntary Control Council for Interference by Information)
- FCC** (Federal Communications Commission)
- C-TICK**
- KCC** (Korea Communications Commission)
- BSMI** (Bureau of Standards, Metrology and Inspection)
- cUL** (C- Underwriter's Laboratories, Inc)
- TUV** (Technischer Überwachungs Verein)
- CB**



This marking on the product, accessories or literature indicates that the product and its electronic accessories (e.g. charger, headset, USB cable) should not be disposed of with other household waste at the end of their working life. To prevent possible harm to the environment or human health from uncontrolled waste disposal, please separate these items from other types of waste and recycle them responsibly to promote the sustainable reuse of material resources.

Household users should contact either the retailer where they purchased this product, or their local government office, for details of where and how they can take these items for environmentally safe recycling.

Business users should contact their supplier and check the terms and conditions of the purchase contract. This product and its electronic accessories should not be mixed with other commercial wastes for disposal.

FCC

	<p>CAUTION : Changes or modifications not expressly approved by the part responsible for compliance could void the user's authority to operate the equipment.</p>
<p>Class B</p>	<p>Note : This equipment has been tested and found to comply with the limits for a Class B digital device, pursuant to part 15 of the FCC Rules. These limits are designed to provide reasonable protection against harmful interference in a residential installation. This equipment generates uses and can radiate radio frequency energy and, if not installed and used in accordance with the instructions, may cause harmful interference to radio communications, However, there is no guarantee that interference will not occur in a particular installation. If this equipment does cause harmful interference to radio or television reception, which can be determined by turning the equipment off and on, the user is encouraged to try to correct the interference by one or more of the following measures:</p> <ul style="list-style-type: none"> - Reorient or relocate the receiving antenna. - Increase the separation between the equipment and receiver. - Connect the equipment into an outlet on a circuit different from that to which the receiver is connected. - Consult the dealer or an experienced radio/TV technician for help.

Warranty Information

The following limited warranty applies to the Samsung External Hard Drive but does not supersede regional and national laws and regulations.

Limited Warranty

Samsung makes the following limited warranties during the warranty period: (a) the Products will function properly under normal use; (b) the Products will be free from defects in materials or workmanship; (c) the Products will conform to the published specifications; and (d) the Products will conform to any additional specifications agreed to in writing by the parties.

Samsung warranties do not cover any problem that is caused by (a) commercial use; accident; abuse; neglect; shock; electrostatic discharge; heat or humidity beyond product specifications; improper installation; operation; maintenance or modification; or (b) any misuse contrary to the instructions in the user's manual; or (c) lost passwords; or (d) malfunctions caused by other equipment.

Our limited warranties are void if a product is returned with removed, damaged, or tampered labels or any alterations (including removal of any component or external cover). Our warranties do not cover data loss – back up the contents of your drive to a separate storage medium on a regular basis. Also, consequential damages; incidental damages; and costs related to data recovery, removal and installation are not recoverable under our warranties.

Warranty Period

The warranty period for product is three (3) years from the documented date of purchase from Samsung or a Samsung' authorized reseller.

Customer Service

To request warranty service, please contact the place of purchase, or visit our web site (www.samsunghdd.com) for information on obtaining service or an RMA (Return Material Authorization) number. Submit your phone number, e-mail, address, name, product model, and serial number(s) and an RMA number with all pertinent information will be provided to you for returning product to Samsung. When you return the product to Samsung, the product must be properly packaged in original packing with a traceable forwarder and freight prepaid to the return address listed on the RMA. Remember to write the RMA number on the out side of box, or the shipment will be refused and returned to you at freight collect.

Samsung, or an authorized Samsung service center, will replace your product with a functionally equivalent product. Samsung will not return your original drive and data recovery is not included.

It is highly recommended that you backup your data. Once your drive is received at Samsung, the ownership of the product and all content therein will be transferred to Samsung.

Please contact Samsung with any comments or inquiries at www.samsunghdd.com



Samsung Electronics Co., Ltd.

STORAGE SYSTEM DIVISION

HEAD OFFICE: 416, MAETAN-3 DONG, YEONGTONG-GU, SUWON SI, GYEONGGI-DO, KOREA, 443-742

FAX: 82-54-479-5801

Copyright

Samsung Electronics reserves all copyrights to the content of this manual. Copyright laws prohibit reproduction of this manual in part or whole by any third party without the explicit consent of Samsung Electronics.

Samsung Electronics does not assume any patent responsibility for the use of information contained in this manual.

Disclaimer

This user's manual has been subjected to thorough reviews and verifications to ensure accuracy of its content and contains information that's pertinent to the model and series it describes at the time of publication. However, content of this manual and/or product specifications are subject to change without prior notice and with no direct or indirect liability on Samsung Electronics' part concerning such change.