

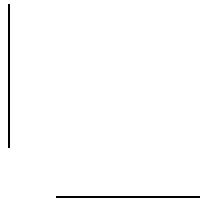

.....  
*ST3491 Family:*  
.....  
***ST3250A, ST3291A***  
.....  
***ST3391A, ST3491A***  
.....  
***AT Interface Drives***  
.....  
*Product Manual*  
.....

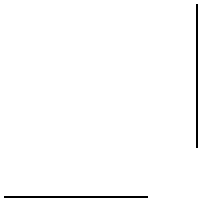

.....  
*ST3491 Family:*  
.....  
***ST3250A, ST3291A***  
.....  
***ST3391A, ST3491A***  
.....  
***AT Interface Drives***  
.....  
*Product Manual*  
.....



© 1994 Seagate Technology, Inc. All rights reserved  
Publication Number: 36254-004, Rev. B  
April 1994

Seagate®, Seagate Technology® and the Seagate logo are registered trademarks of Seagate Technology, Inc. SeaCache™ is a trademark of Seagate Technology, Inc. Other product names are trademarks or registered trademarks of their owners.

Seagate reserves the right to change, without notice, product offerings or specifications. No part of this publication may be reproduced in any form without written permission from Seagate Technology, Inc.

## Contents

1.0	Specification summary . . . . .	1
1.1	Formatted capacity . . . . .	1
1.1.1	Physical organization . . . . .	1
1.1.2	Recommended logical configuration . . . . .	2
1.2	Drive dimensions . . . . .	2
1.2.1	Functional specifications . . . . .	3
1.3	Reliability . . . . .	3
1.4	Acoustics . . . . .	3
1.5	Seek time . . . . .	4
1.6	Auto-park . . . . .	4
1.7	Shock and vibration . . . . .	4
1.8	Environment . . . . .	5
1.8.1	Ambient temperature . . . . .	5
1.8.2	Temperature gradient . . . . .	5
1.8.3	Relative humidity . . . . .	5
1.8.4	Altitude . . . . .	6
1.9	Power requirements . . . . .	6
1.9.1	Input noise . . . . .	6
1.9.2	Start and stop time . . . . .	6
1.9.3	Idle and Standby timers . . . . .	7
1.9.4	Power-management modes . . . . .	7
1.9.5	Power consumption . . . . .	9
1.10	Agency listings . . . . .	9
1.11	FCC verification . . . . .	10
2.0	Hardware description . . . . .	11
2.1	Handling and static-discharge precautions . . . . .	11
2.2	Drive mounting . . . . .	12
2.3	Drive I/O connector . . . . .	15
3.0	Interface description . . . . .	17

3.1 AT interface connector pin assignments . . . . .	17
3.2 Bus signal levels . . . . .	17
3.3 Configuration jumpers . . . . .	19
3.3.1 Factory test configuration . . . . .	20
3.3.2 Master/slave configuration . . . . .	20
3.3.3 No DASP– configuration . . . . .	20
3.4 Cable select configuration . . . . .	21
3.5 Drive activity LED . . . . .	22
3.6 Supported AT commands . . . . .	23
3.6.1 Identify Drive command (E <sub>C<sub>H</sub></sub> ) . . . . .	25
3.6.2 Set Features command (E <sub>F<sub>H</sub></sub> ) . . . . .	28
3.6.3 Set Multiple Mode command (C <sub>6<sub>H</sub></sub> ) . . . . .	30
3.6.4 Read Multiple command (C <sub>4<sub>H</sub></sub> ) . . . . .	30
3.6.5 Write Multiple command (C <sub>5<sub>H</sub></sub> ) . . . . .	31
3.7 Onboard drive diagnostics . . . . .	32
3.8 ECC performance tests . . . . .	32
3.9 Supported BIOS . . . . .	33

## Figures

Figure 1. Typical startup current profile . . . . .	8
Figure 2. Standard mounting dimensions . . . . .	13
Figure 3. Metric mounting dimensions . . . . .	14
Figure 4. AT interface drive connector . . . . .	15
Figure 5. AT connector pin assignments . . . . .	18
Figure 6. Connectors and jumpers . . . . .	19
Figure 7. Connecting cable-selected drives . . . . .	21

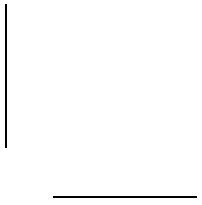
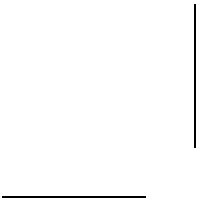

## 1.0 Specification summary

### 1.1 Formatted capacity

The drive is low-level formatted at the factory. You cannot low-level format the drive.

	<b>ST3250A</b>	<b>ST3291A</b>
Formatted capacity (Mbytes*)	213.9	272.7
Total sectors	417,792	532,700

	<b>ST3391A</b>	<b>ST3491A</b>
Formatted capacity (Mbytes*)	341.3	428.1
Total sectors	666,624	836,070

\* One megabyte equals one million bytes.

#### 1.1.1 Physical organization

	<b>ST3250A</b>	<b>ST3291A</b>
Heads	2	4
Discs	1	2

	<b>ST3391A</b>	<b>ST3491A</b>
Heads	4	4
Discs	2	2

### 1.1.2 Recommended logical configuration

You can operate the drive using many different logical configurations, provided the number of sectors per track does not exceed 256. However, in DOS the number of sectors per track must be less than or equal to 63. When establishing the logical configuration, set the number of sectors per track and the number of heads to satisfy the following relationship:

$$16 \leq (\text{sectors per track}) \times (\text{heads}) \leq 4,096$$

When you configure the drive in CMOS, the total sectors cannot exceed the physical capacity of the drive. The total sectors is determined by the following formula:

$$\text{total sectors} = (\text{logical heads}) \times (\text{logical sectors per track}) \times (\text{logical cylinders})$$

To maximize the capacity of the drive, the following geometry is recommended:

	<b>ST3250A</b>	<b>ST3291A</b>
Cylinders	1,024	761
Heads	12	14
Sectors per track	34	50
	<b>ST3391A</b>	<b>ST3491A</b>
Cylinders	768	899
Heads	14	15
Sectors per track	62	62

The drive is configured in translation mode. You can verify the number of cylinders, sectors per track and heads by using the Identify Drive (ECH) command. See the *Seagate ATA Interface Reference Manual*, publication number 36111-xxx, for details about the Identify Drive command.

### 1.2 Drive dimensions

Height (max)	1.00 inch (25.4 mm)
Width (max)	4.02 inches (102.1 mm)
Depth (max)	5.77 inches (146.6 mm)
Weight (max)	1.3 lb (0.59 Kg)

### 1.2.1 Functional specifications

Interface	AT
Internal data transfer rate (Mbits/sec)	18.7 to 32*
External data transfer rate (Mbytes/sec)	11.1**
Spindle speed $\pm 0.5\%$ (RPM)	3,811
SeaCache™ buffer (Kbytes)	120
Zone Bit Recording method	RLL (1,7)
Bytes per sector	512
Recording density, max (BPI)	55,200
Flux density, max (FCI)	41,400
Track density, max (TPI)	3,081

\* The internal data transfer rate for the ST3491A is 18.7 to 32.

\*\* This is the external data transfer rate during a cache transfer. When the drive is not using the cache, the transfer rate is 5.0 Mbytes per second.

### 1.3 Reliability

The MTBF specification assumes nominal power at sea level with an ambient temperature of 25°C.

Nonrecoverable errors	1 per $10^{13}$ bits read
MTBF	300,000 power on hours
Contact start-stop (CSS)	40,000 cycles
MTTR	30 minutes
Service life	5 years

### 1.4 Acoustics

Sound pressure is measured at idle from 1 meter above the drive top cover.

Sound pressure, typ	29 dBA
Sound pressure, max	33 dBA

## 1.5 Seek time

All performance measurements are taken using a 25 MHz 486 AT computer (or faster) with a 8.3 MHz I/O bus. The measurements are taken with nominal power at sea level and 25°C ambient temperature. The specifications in the table below are defined as follows:

- Track-to-track seek time is an average of all possible single-track seeks in both directions.
- Average seek time is a true statistical random average of at least 5,000 measurements of seeks between random tracks, less overhead.
- Full-stroke seek time is one-half the time needed to seek from the first data cylinder to the maximum data cylinder and back to the first data cylinder. The full-stroke average is determined by measuring 100 full-stroke seeks in both directions.

Model	Track-to-track typ (msec)	Average typ (msec)	Full-stroke typ (msec)	Latency (msec)
ST3250A	5	15	34	7.87
ST3291A	5	13	32	7.87
ST3391A	5	14	33	7.87
ST3491A	5	15	34	7.87

## 1.6 Auto-park

Upon power-down, the read/write heads automatically move to the shipping zone. The heads park inside the maximum data cylinder. When power is applied, the heads recalibrate to track 0.

## 1.7 Shock and vibration

Shock measurements are based on an 11 msec, half sine wave shock pulse, not to be repeated more than twice per second. The specifications in the table below are defined as follows:

- During normal operating shock and vibration, the drive sustains no physical damage and reads and writes data without errors.

- During abnormal operating shock and vibration, the drive sustains no physical damage, but performance is adversely affected.
- During nonoperating shock and vibration, the read/write heads are in the shipping zone and the drive sustains no physical damage.

	<b>Normal operating</b>	<b>Abnormal operating</b>	<b>Nonoperating</b>
Shock	2 Gs	10 Gs	75 Gs
5–22 Hz vibration	0.020-inch displacement	0.030-inch displacement	0.160-inch displacement
22–500 Hz vibration	0.50 Gs	0.75 Gs	4.00 Gs

## 1.8 Environment

The acceptable environmental conditions for the drive are specified below. The specifications in this section are defined as follows:

- Operating specifications assume that the drive is powered up.
- Nonoperating specifications assume that the drive is packaged as it was shipped from the factory.

### 1.8.1 Ambient temperature

Operating	5° to 55°C (41° to 131°F)
Nonoperating	–40° to 60°C (–40° to 140°F)

### 1.8.2 Temperature gradient

Operating (max)	20°C per hour (36°F per hour)
Nonoperating (max)	30°C per hour (54°F per hour)

### 1.8.3 Relative humidity

Operating	8% to 80% noncondensing Maximum wet bulb 29.4°C (85.0°F)
Nonoperating	5% to 95% noncondensing Maximum wet bulb 40.0°C (104°F)

### 1.8.4 Altitude

Operating	-1,000 ft to 10,000 ft (-305 m to 3,050 m)
Nonoperating	-1,000 ft to 40,000 ft (-305 m to 12,200 m)

## 1.9 Power requirements

Except during a write operation, you can apply power to the drive or remove power from the drive in any sequence without losing data or damaging the drive.

### 1.9.1 Input noise

The drive is expected to operate with a maximum of 150 mV peak-to-peak triangular wave injected noise at the power connector. The frequency is 10 Hz to 20 MHz with equivalent resistive loads.

	<b>+5V</b>	<b>+12V</b>
Voltage tolerance including noise	± 5%	± 5% ± 10% during spinup

### 1.9.2 Start and stop time

After 10 seconds, the drive is ready. Typical and maximum start and stop times are shown in the following table. See Figure 1 on page 8 for the typical startup current profile.

	<b>Typical</b>	<b>Maximum</b>
Start time	7 sec	10 sec
Stop time	6 sec	9 sec

### 1.9.3 Idle and Standby timers

The drive can enter the Idle mode or the Standby mode by either of two methods:

- The computer sends either the Idle Immediate command or the Standby Immediate command.
- The Idle timer or the Standby timer counts down to zero.

At power-on, the Idle and Standby timers are disabled; this is the default mode of operation set at the factory. You can set the timer delays using the computer setup utility. If the Idle timer is enabled, each time the drive completes a read, write or seek, the drive reinitializes the Idle timer and it begins counting down from the specified delay to zero.

If the Idle timer reaches zero before any drive activity is required, the drive switches to the Idle mode. Then, if the Standby timer is enabled, that timer begins counting down. For details, refer to the *Seagate ATA Interface Reference Manual*, publication number 36111-xxx.

In both the Idle and Standby modes, the drive accepts all commands and returns to the Active mode any time disc access is necessary.

### 1.9.4 Power-management modes

The following power-management modes are supported by the drive:

- **Active mode.** The drive is seeking, reading or writing.
- **Idle mode.** When the drive receives an Idle Immediate command, or the idle timer counts down to zero, the drive enters the Idle mode. In Idle mode, the spindle remains up to speed and the heads are parked in the shipping zone. The SeaCache™ buffer remains enabled, and the drive accepts all commands and returns to the Active mode whenever a seek, read or write operation is needed.
- **Standby mode.** When the drive receives a Standby Immediate command, or the standby timer has counted down to zero, the drive enters the Standby mode. In the Standby mode, the SeaCache buffer remains enabled, the heads are parked in the shipping zone and the spindle is stopped. The drive accepts all commands and returns to the Active mode whenever a seek, read or write operation is needed.

(continued)

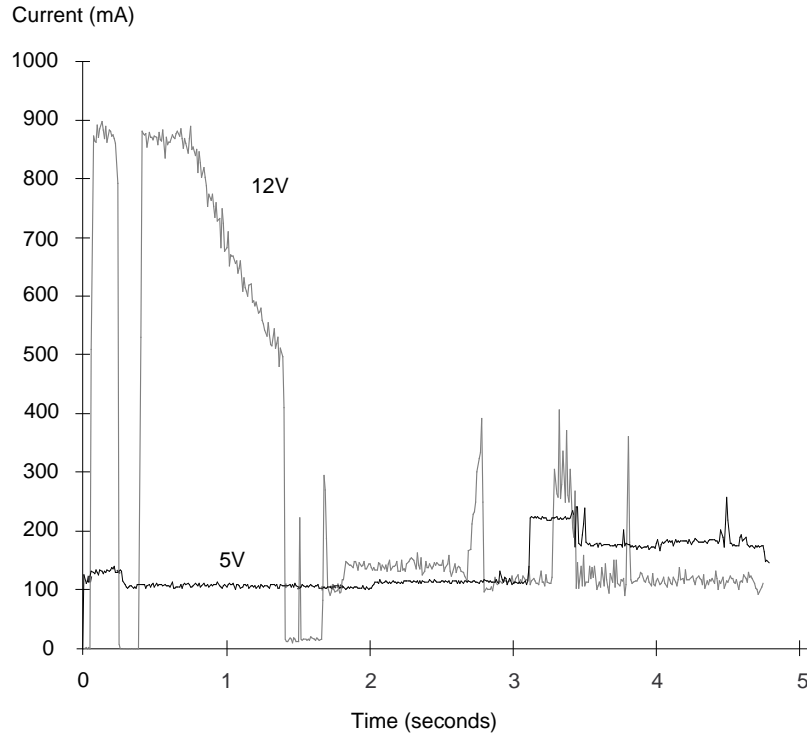

**Figure 1. Typical startup current profile**

*(continued from previous page)*

- **Sleep mode.** When the drive receives a Sleep Immediate command, it enters the Sleep mode. The heads are parked in the shipping zone and the spindle is at rest. When a hard reset or soft reset is sent from the computer, the drive returns to the Active mode. After a soft reset, all current emulation and translation parameters remain intact.

### 1.9.5 Power consumption

Power consumption is measured according to the following guidelines:

- All measurements are taken at sea level with an ambient temperature of 25°C.
- All typical measurements are taken using nominal voltages; the peak startup power is measured using the nominal voltages.
- Seeking current measurements are taken using an RMS meter while the drive is randomly seeking with two spindle rotations between each seek.

Mode	Current (amps)		Power (watts)
	+12V	+5V	
Spinup (peak)	1.200	0.300	8.000 **
Active			
Seeking (typ)	0.290	0.180	4.400
Read/write (typ)	0.150	0.280	3.200
Idle* (typ)	0.115	0.080	1.800
Standby* (typ)	0.020	0.080	0.640
Sleep* (typ)	0.020	0.065	0.570

\* These power dissipation values apply only when power management is enabled. To enable power management, use the computer setup utility.

\*\* Spinup power is averaged over 7 seconds.

### 1.10 Agency listings

This drive is listed with agencies as follows:

- UL 1950
- CSA C22.2 No. 0-M91 and CSA C22.2 No. 950-M89
- EN 60950/10.92 as tested by TUV-Rheinland, North America

### 1.11 FCC verification

The ST3491 family drives are intended to be contained solely within a personal computer or similar enclosure (not attached to an external device). As such, a drive is considered to be a subassembly even when individually marketed to the customer. As a subassembly, no Federal Communications Commission authorization, verification or certification of the device is required.

Seagate Technology, Inc. has tested these drives in an enclosure as described above to ensure that the total assembly (enclosure, disc drive, motherboard, power supply, etc.) does comply with the limits for a Class B computing device, pursuant to Subpart J of Part 15 of the FCC rules. Operation with noncertified assemblies is likely to result in interference to radio and television reception.

**Radio and television interference.** This equipment generates and uses radio frequency energy and, if not installed and used in strict accordance with the manufacturer's instructions, may cause interference to radio and television reception.

This equipment is designed to provide reasonable protection against such interference in a residential installation. However, there is no guarantee that interference will not occur in a particular installation. If this equipment does cause interference to radio or television, which can be determined by turning the equipment on and off, you are encouraged to try one or more of the following corrective measures:

- Reorient the receiving antenna.
- Move the device to one side or the other of the radio or TV.
- Move the device farther away from the radio or TV.
- Plug the equipment into a different outlet so that the receiver and computer are on different branch outlets.

If necessary, you should consult your dealer or an experienced radio/television technician for additional suggestions. You may find helpful the following booklet prepared by the Federal Communications Commission: *How to Identify and Resolve Radio-Television Interference Problems*. This booklet is available from the Superintendent of Documents, US Government Printing Office, Washington, DC 20402. Refer to publication number 004-000-00345-4.

## 2.0 Hardware description

The ST3491 family drives use the industry-standard AT interface. These drives support 16-bit data transfers and DMA and PIO modes. (See Set Features command description.) You can connect up to two drives on the same bus using a daisy-chain cable.

### 2.1 Handling and static-discharge precautions

After you unpack the drive, and before you install it in a computer, be careful not to damage it through mishandling. Observe the following standard handling and static-discharge precautions:

**Caution:**

- Keep the drive in its static-shielded bag until you are ready to complete the installation. Do not attach any cables to the drive while it is in its static-shielded bag.
- Before handling the drive, put on a grounded wrist strap, or ground yourself frequently by touching the metal chassis of a computer that is plugged into a grounded outlet. Wear a grounded wrist strap throughout the entire installation procedure.
- Handle the drive by its edges or frame only.
- The drive is extremely fragile—handle it with care. Do not press down on the drive top cover.
- Always rest the drive on a padded, antistatic surface until you mount it in the computer.
- Do not touch the connector pins or the printed circuit board. Do not touch the printed circuit cable between the circuit board and the head/disc assembly.
- Avoid wool or synthetic clothing, carpeting, plastics, and Styrofoam; these items cause static discharge.
- Do not remove the factory-installed labels from the drive or cover them with additional labels. If you do, you void the warranty. Some factory-installed labels contain information needed to service the drive. Others are used to seal out dirt and contamination.

## 2.2 Drive mounting

You can mount the drive in any orientation using either the bottom or the side mounting holes, as described below. Figure 2 on page 13 and Figure 3 on page 14 show different dimension drawings for standard and metric drives, respectively.

**Note.** The only difference between standard and metric drives is the position of the mounting holes. The overall size of the drives is the same.

- Standard-size drives have an “S” stamped on the frame runner and accept 6-32 UNC screws.
- Metric drives have an “M” stamped on the frame runner and accept M3 screws.

**Bottom mounting holes.** Insert four mounting screws not more than 0.20 inches (6 full turns) into the drive frame.

**Side mounting holes.** Insert four mounting screws not more than 0.13 inches (4 full turns) into the drive frame.

**Caution.** To prevent damage to the drive:

- Use only mounting screws of the correct size and length.
- Lightly tighten the mounting screws—do not apply more than 6 inch-lb of torque.

In Figure 2, the dimensions are shown in inches. This figure for standard-size drives shows the mounting holes in different positions when compared with metric drives shown in Figure 3 on page 14.

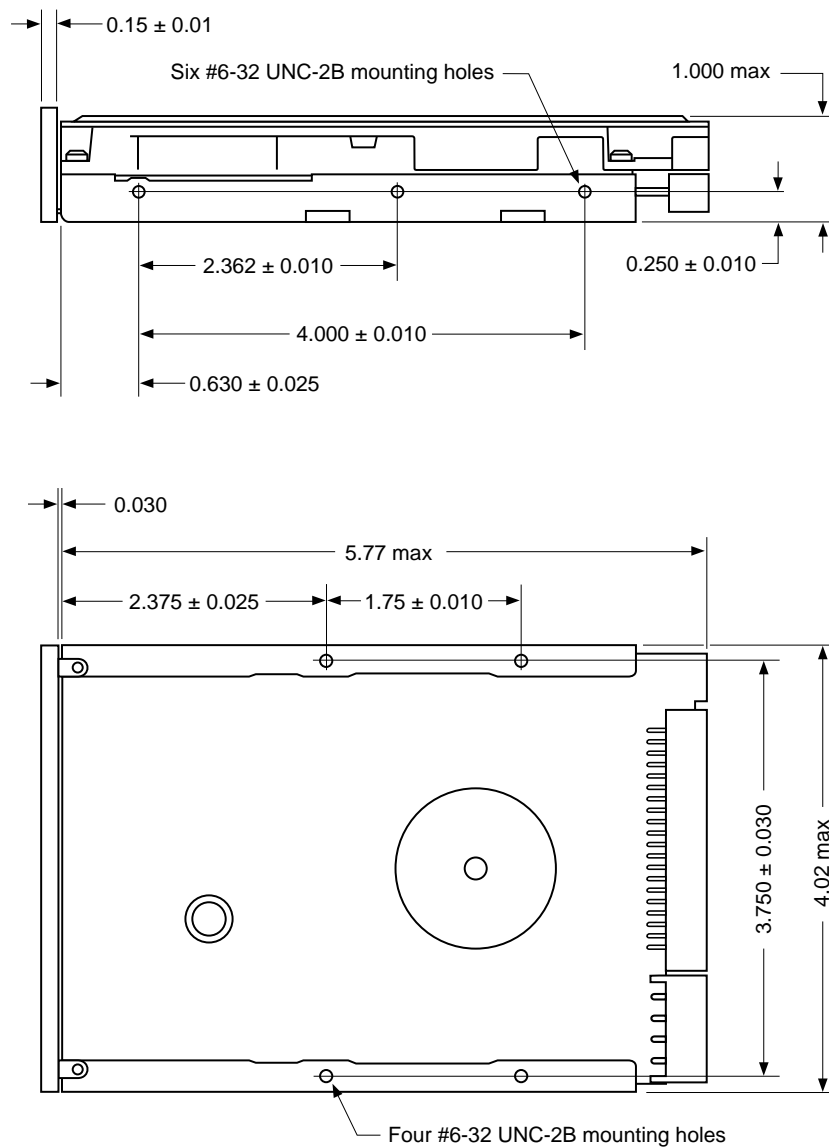

**Figure 2. Standard mounting dimensions**

In Figure 3, the dimensions are shown in millimeters. This figure shows the mounting holes in different positions when compared with Figure 2 on page 17.

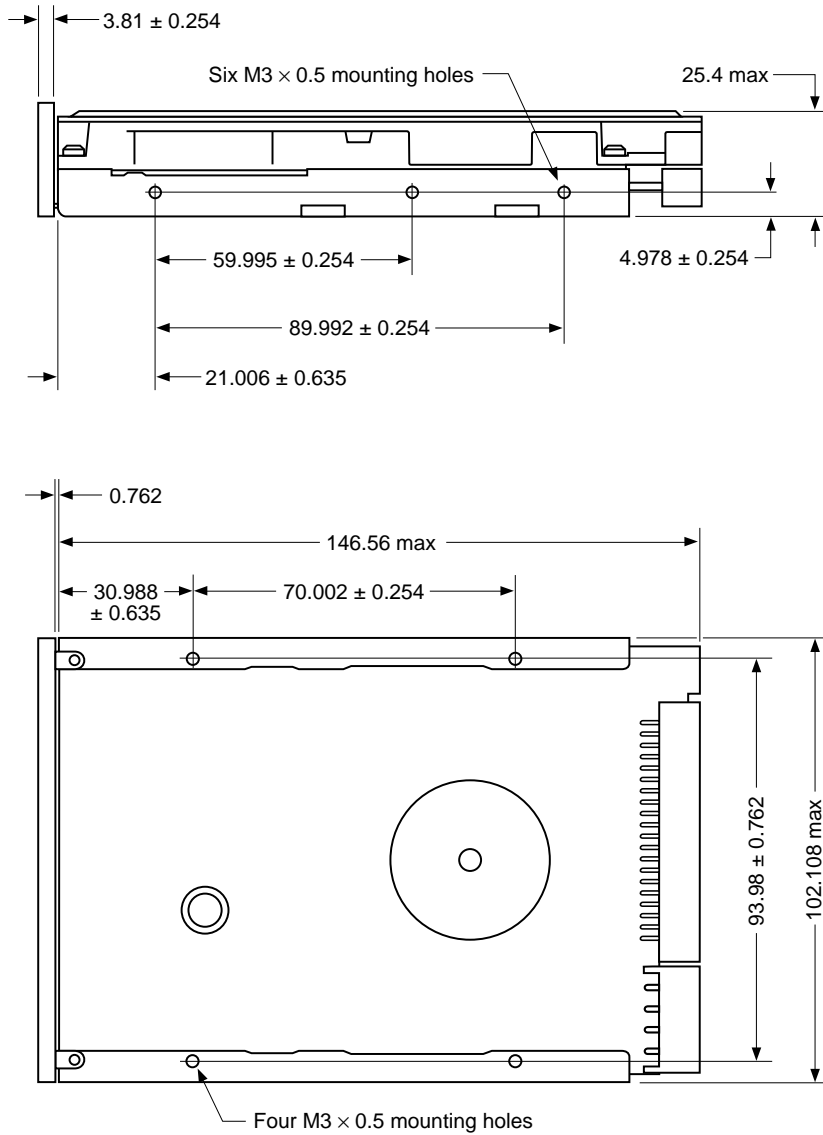

Figure 3. Metric mounting dimensions

### 2.3 Drive I/O connector

The drive interface connector has 40 pins, with 2 rows of 20 male pins on 100-mil centers.

Use a 40-pin, nonshielded cable connector with 2 rows of 20 female contacts on 100-mil centers. The maximum cable length is 18 inches (457 mm). Strain relief is recommended. The recommended part numbers are listed below. The connector is shown in Figure 2.

AMP	1-499496-0
Du Pont	66900-040

Dimensions are in inches

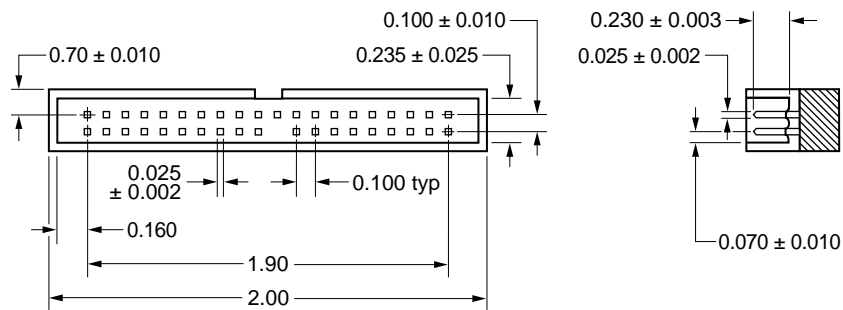
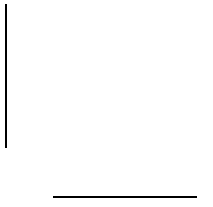
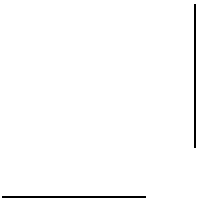

Figure 4. AT interface drive connector



## 3.0 Interface description

The drive complies with all ATA interface specifications. The interface consists of single-ended, TTL-compatible receivers and drivers communicating through a 40-conductor flat-ribbon, nonshielded cable with a maximum length of 18 inches (0.46 meters) using an asynchronous interface protocol. The drivers can sink up to 24 mA and drive a load up to 300 pF.

### 3.1 AT interface connector pin assignments

The signal name and signal direction for each I/O connector pin is described in Figure 5 on page 18. See the *Seagate ATA Interface Reference Manual*, publication number 36111-xxx, for a complete description of each pin.

Signal names are in upper case. If the signal name is followed by a minus sign (-), the signal is active low. Otherwise, the signal is active high.

**Note.** The drive does not use the SPSYNC- signal.

### 3.2 Bus signal levels

Signals that the drive sends have the following output characteristics, measured at the drive connector.

Logic low	0 to 0.4V
Logic high	2.5 to 5.25V

Signals that the drive receives must have the following input characteristics, measured at the drive connector.

Logic low	0 to 0.8V
Logic high	2.0 to 5.25V

Drive pin #	Signal name	Host pin # and signal description
1	Reset-	1 Host Reset
2	Ground	2 Ground
3	DD7	3 Host Data Bus Bit 7
4	DD8	4 Host Data Bus Bit 8
5	DD6	5 Host Data Bus Bit 6
6	DD9	6 Host Data Bus Bit 9
7	DD5	7 Host Data Bus Bit 5
8	DD10	8 Host Data Bus Bit 10
9	DD4	9 Host Data Bus Bit 4
10	DD11	10 Host Data Bus Bit 11
11	DD3	11 Host Data Bus Bit 3
12	DD12	12 Host Data Bus Bit 12
13	DD2	13 Host Data Bus Bit 2
14	DD13	14 Host Data Bus Bit 13
15	DD1	15 Host Data Bus Bit 1
16	DD14	16 Host Data Bus Bit 14
17	DD0	17 Host Data Bus Bit 0
18	DD15	18 Host Data Bus Bit 15
19	Ground	19 Ground
20	(removed)	20 (No Pin)
21	DMARQ	21 DMA Request
22	Ground	22 Ground
23	DIOW-	23 Host I/O Write
24	Ground	24 Ground
25	DIOR-	25 Host I/O Read
26	Ground	26 Ground
27	IORDY	27 I/O Channel Ready
*28	CSEL	28 Cable Select
29	DMACK-	29 DMA Acknowledge
30	Ground	30 Ground
31	INTRQ	31 Host Interrupt Request
32	IOCS16-	32 Host 16 Bit I/O
33	DA1	33 Host Address Bus Bit 1
*34	PDIAG-	34 Passed Diagnostics
35	DA0	35 Host Address Bus Bit 0
36	DA2	36 Host Address Bus Bit 2
37	CS1FX-	37 Host Chip Select 0
38	CS3FX-	38 Host Chip Select 1
*39	DASP-	39 Drive Active or Slave Present
40	Ground	40 Ground

\*Indicates master-slave signals (details shown below).

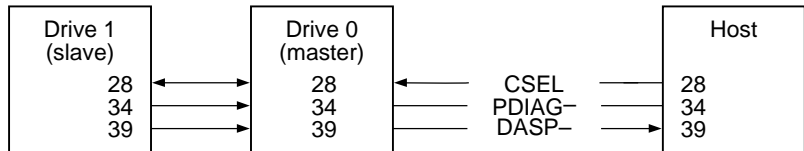

Figure 5. AT connector pin assignments

### 3.3 Configuration jumpers

Figure 6 shows the location of the options jumper block. The jumper block accepts 2-mm (0.079-inch) jumpers.

**Caution.** If you use a jumper that is not the correct size, you may damage the jumper block and the jumper. Use the jumpers supplied with the drive.

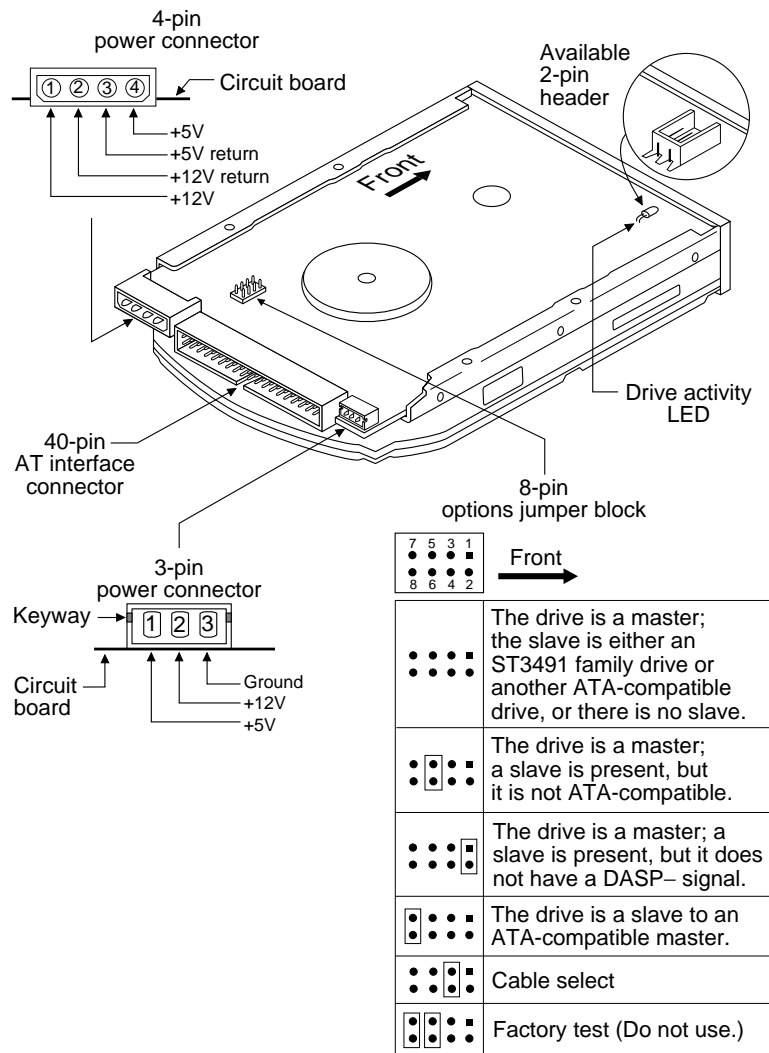

Figure 6. Connectors and jumpers

### 3.3.1 Factory test configuration

Do not install jumpers on pins 5 and 6 and pins 7 and 8 at the same time. When jumpers are installed in both of these positions, the heads continuously seek back and forth across the media and the drive ignores all control signals sent by the interface.

### 3.3.2 Master/slave configuration

In a two-drive system, one drive must be configured as the master and the other as the slave. In a single-drive system, configure the drive as a master. To configure the drive as a master or a slave, install jumpers according to the table in Figure 6 on page 19.

**Note.** Do not configure an ST3491 family drive as a slave to a non-ATA-compatible master drive.

### 3.3.3 No DASP– configuration

When a jumper is installed on pins 1 and 2 of the options jumper block of the master, the master uses the PDIAG– signal from the slave to recognize that the slave is present during startup and ready for normal operation. Otherwise the drive uses the DASP– signal according to the CAM ATA specification 3.2.

This configuration allows the ST3491 family drives to be compatible with drives that do not use the PDIAG– signal.

### 3.4 Cable select configuration

If your computer and both of your drives support cable select (CSEL), you can use the cable select option to determine the master and slave. To configure your drives to use cable select, you need to install jumpers and to use a special cable-select cable as follows:

- Install a jumper on pins 3 and 4 of the options jumper block as shown in Figure 6 on page 19. When a jumper is installed in this position, the drive ignores master/slave jumpers installed on pins 7 and 8.
- You must use an interface ribbon cable built for cable-select. To make a drive the master, attach it to the connector that has the CSEL signal line connected to pin 28. To make a drive the slave, attach it to the connector that has pin 28 unconnected (CSEL is not carried to pin 28 of that cable connector.) Note that CSEL is grounded at the host.

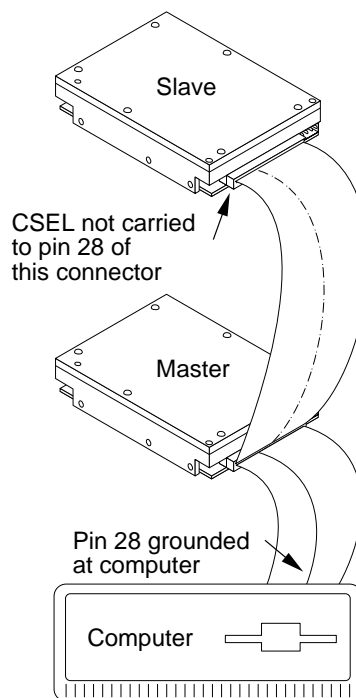

Figure 7. Connecting cable-selected drives

### 3.5 Drive activity LED

The drives are available with either of two activity LED options:

- An LED permanently mounted on the drive circuit board, or
- A two-pin header on the drive circuit board that accepts an LED or a connector for a remote LED cable.

Both options are shown in Figure 6 on page 19.

If your drive has an LED mounted on its circuit board or an LED connected by a cable to a two-pin header, the drive automatically displays its activity on this LED.

In addition, the drive sends a drive activity signal to the LED at the front panel of your computer using pin 39 of the I/O connector.

### 3.6 Supported AT commands

This section lists all ATA commands implemented in the ST3491 family drives and describes certain commands in detail. Some commands, as mentioned in the text, supplement the standard ATA commands. For a complete description of all AT interface commands, refer to the *Seagate ATA Interface Reference Manual*, part number 36111-xxx. Where indicated, additional information is provided by the Small Form Factor specification, SFF-8011 Rev 1.1, September 18, 1993.

The table on page 24 lists all commands implemented in the ST3491 family drives. The table uses the following abbreviations:

- FR Features register
- SC Sector count register
- SN Sector number register
- CY Cylinder register
- DH Drive/head register
  - n This register does not contain a valid parameter for this command.
  - y This register contains a valid parameter for this command. In the drive/head register, both the drive and head parameters are valid for this command.
  - D The drive/head register contains a valid drive parameter for this command. The head parameter is not valid for this command.

Command name	Command code (in hex)	Parameters used				
		FR	SC	SN	CY	DH
Active and Set Idle Timer	FB	n	y	n	n	D
Active Immediate	F9	n	n	n	n	D
Check Idle Mode	FD	n	y	n	n	D
Check Power Mode	98, E5	n	y	n	n	D
Execute Drive Diagnostics	90	n	n	n	n	D
Format Track	50	n	y	n	y	y
Identify Drive	EC	n	n	n	n	D
Idle	97, E3	n	y	n	n	D
Idle and Set Idle Timer	FA	n	y	n	n	D
Idle Immediate	95, F8, E1	n	n	n	n	D
Initialize Drive Parameters	91	n	y	n	n	y
Read DMA	C8, C9	—	y	y	y	y
Read Long	22, 23	n	y	y	y	y
Read Multiple	C4	n	y	y	y	y
Read Sector	20, 21	n	y	y	y	y
Read Sector Buffer	E4	n	n	n	n	D
Read Verify Sector	40, 41	n	y	y	y	y
Recalibrate	1X	n	n	n	n	D
Seek	7X	n	n	y	y	y
Set Features	EF	y	n	n	n	D
Set Multiple Mode	C6	n	y	n	n	D
Set Sleep Mode	99, E6	n	n	n	n	D
Standby	96, E2	n	n	n	n	D
Standby Immediate	94, E0	n	n	n	n	D
Write DMA	CA, CB	—	y	y	y	y
Write Long	32, 33	n	y	y	y	y
Write Multiple	C5	n	y	y	y	y
Write Sector	30, 31	n	y	y	y	y
Write Sector Buffer	E8	n	n	n	n	D

### 3.6.1 Identify Drive command (ECH)

The Identify Drive command transfers information about the drive to the host following power up. The data is organized as a single 512-byte block of data; the block's contents are shown in the table below. All reserved bits or words must be set to zero. Parameters listed with an "x" are drive-specific or vary with the state of the drive.

The sector buffer parameters for ST3491 family drives are listed in the table below. The Logical Configuration parameters shown below are for the ST3250A. For a complete description of the Identify Drive command, see the *Seagate ATA Interface Reference Manual*, publication number 36111-xxx.

Word	Description	Value
0	Configuration information Bit 10: 1 = disc transfer greater than 10 Mbits/sec Bit 6: 1 = fixed drive Bit 4: 1 = head switch time > 15 $\mu$ sec Bit 3: 1 = not MFM encoded Bit 1: 1 = hard sectored disc	045AH
1	Number of fixed cylinders (default logical emulation)	ST3250A: 400H ST3291A: 2F9H ST3391A: 300H ST3491A: 383H
2	ATA reserved	0000H
3	Number of heads (default)	ST3250A: CH ST3291A: EH ST3391A: EH ST3491A: FH
4	Number of unformatted bytes per track	8D90H
5	Number of unformatted bytes per sector	0248H
6	Number of sectors per track (default logical emulation)	ST3250A: 22H ST3291A: 32H ST3391A: 3EH ST3491A: 3EH
7-9	ATA reserved (vendor-unique)	0000H

*continued*

Word	Description	Value
10–19	Serial number: (20 ASCII characters, 0000H = not specified)	Drive-unique value expressed as ASCII characters
20	Controller type = dual-ported multisector buffer with caching	0003H
21	Buffer size (number of 512-byte sectors)	00F0H (240D)
22	Number of ECC bytes available (R/W Long)	0010H (16D)
23–26	Firmware revision (8 ASCII character string).	Drive-dependent string
27–46	Drive model number (40 ASCII characters, padded to end of string)	Drive-dependent string: ST3xxxA-xx or ST3xxxA-xxx
47	Maximum sectors per interrupt on read/write multiple	0010H
48	Double word I/O (not supported)	0000H
49	DMA data transfer and IORDY (supported)	0900H
50	ATA reserved	0000H
51*	PIO data transfer cycle timing mode	0200H
52	Single word DMA transfer cycle timing mode	0200H
53	Bit 0 = 1 indicates the fields reported in words 54–58 are valid; Bit 1 = 1 indicates the fields reported in words 64–8 are valid.	0003H
54	Number of cylinders (current emulation mode)	See Section 1.
55	Number of heads (current emulation mode)	See Section 1.

Word	Description	Value
56	Number of sectors per track (current emulation mode)	See Section 1.
57–58	Number of sectors (current emulation mode)	See Section 1.
59	Current multiple sector setting	01xxH
60–61	LBA total sectors	0000H
62	Single word DMA active / modes supported	0000H
63	Multiword DMA active / modes supported	0103H
64	Advanced PIO modes supported (Mode 3 supported)	0001H
65	Minimum multiword DMA transfer cycle time per word	96H (150 nsec)
66	Recommended multiword DMA transfer cycle time per word	016BH (363 nsec)
67	Minimum PIO cycle time without IORDY flow control	016BH (363 nsec)
68	Minimum PIO cycle time with IORDY *	00B4H (180 nsec)
69 – 127	ATA reserved	0000H
128 – 159	Seagate reserved	xxxxH
160 – 255	ATA reserved	0000H

\* Cycle times less than 363 nsec require IORDY.

### 3.6.2 Set Features command (EF<sub>H</sub>)

The Set Features command (command code EF<sub>H</sub>) is used by the host to establish parameters that affect the execution of certain drive features. To use the command: 1) write the Feature value to the Features register; 2) write the Set Features command to the command register.

**Note.** If the value in the Features register is not supported or is invalid, the drive posts an Aborted Command error.

At power-on, or after a hard reset, the feature selections are restored to the factory default values. If 66<sub>H</sub> has been set, a software reset will not change the feature selections (this can be canceled by setting CCH). If 66<sub>H</sub> has not been set, a soft reset will return the settings to the factory defaults.

The following table shows alterable features supported by the ST3941 family drives. Where a factory default value exists, that value is listed.

Byte	Feature description
02 <sub>H</sub>	Enable write cache ( <i>factory default</i> ).
03 <sub>H</sub>	Set value for Set Transfer mode based on value in Sector Count register.
44 <sub>H</sub>	Use maximum length of ECC (16 bytes) on read long/write long commands ( <i>factory default</i> ).
55 <sub>H</sub>	Disable read look-ahead feature.
66 <sub>H</sub>	Use current settings as default (until hard reset or power off).
77 <sub>H</sub>	Disable ECC.
82 <sub>H</sub>	Disable write cache (factory default is OFF)
88 <sub>H</sub>	Enable ECC ( <i>factory default</i> ).
AA <sub>H</sub>	Enable read look-ahead feature ( <i>factory default</i> ).
BB <sub>H</sub>	4 bytes of ECC apply on read long/write long commands.
CCH	Enable reverting to power-on defaults ( <i>factory default</i> ).

### 3.6.2.1 PIO and DMA Data Transfer Modes

The Set Features command can be used to set the type of data transfer mechanism and transfer mode used by the drive. To do this:

1. Write Set Features command value 03H (Set Data Transfer mode) to the Features register, then
2. Write a Transfer Types value to the Sector Count register. The upper 5 bits of this value define the type of data transfer, and the low order 3 bits encode the mode value. The following table identifies allowable Transfer Types values:

Data Transfer Mechanism		Transfer Types value	
Mechanism name	Mode value	Data Upper 5 bits	Lower 3 bits
PIO Transfer Mode (default: Set PIO Mode 2)	2	00000	000
PIO Transfer Mode: Set PIO Mode 2	2	00000	001
PIO Flow Control Transfer Mode: Set PIO Mode = 0	0	00001	000
PIO Flow Control Transfer Mode: Set PIO Mode = 1	1	00001	001
PIO Flow Control Transfer Mode: Set PIO Mode = 2	2	00001	010
PIO Flow Control Transfer Mode: Set PIO Mode = 3	3	00001	011
Multiword DMA Mode	0	00100	000
Multiword DMA Mode	1	00100	001
Reserved		01000	<i>nnn</i>

**Notes:**

1. If the drive does not support a commanded mode, the drive returns an Aborted Command error.

*continued*

2. If the drive receives a Set Features command with a Mechanism and Mode value of 0000 0001 and the drive supports disabling of IORDY, then the drive sets its default PIO transfer mode and disables IORDY.

Reserved values are intended for use in a future specification of an alternative flow control mechanism.

### 3.6.3 Set Multiple Mode command (C6H)

Command code C6H enables the drive to perform Read and Write Multiple operations and establishes the block count for these commands. It is not required that this command is issued prior to every Read Multiple or Write Multiple command.

The Sector Count register is loaded with the number of sectors per block. Drives normally support block sizes of 2, 4, 8 and 16 sectors. However, other block size values may also be supported, depending on the size of the drive's buffer. Upon receipt of the Set Multiple Mode command, the drive sets BSY=1 and checks the Sector Count register.

If the Sector Count register contains a valid value and the block count is supported, the value is loaded for all subsequent Read Multiple and Write Multiple commands and execution of those commands is enabled. If a block count is not supported, an Aborted Command error is posted, and Read Multiple and Write Multiple commands are disabled.

If the Sector Count register contains 0 when the command is issued, Read and Write Multiple commands are disabled.

At power on, or after a hardware reset, the default mode is Read and Write Multiple disabled. If Disable Default has been set in the Features register, then the mode remains the same as that last established prior to a software reset, otherwise it reverts to the default of disabled.

### 3.6.4 Read Multiple command (C4H)

This command (code C4H) is similar to the Read Sectors command. Interrupts are not generated on every sector, but on the transfer of a block that contains the number of sectors defined by a Set Multiple Mode command.

The number of sectors per block to be transferred without intervening interrupts is programmed by the Set Multiple Mode command, which must be executed prior to the Read Multiple command. Interrupts are generated when DRQ is set to 1 at the beginning of each block or partial block.

When the Read Multiple command is issued, the Sector Count register contains the number of sectors (not the number of blocks or the block count) requested.

If the number of requested sectors is not evenly divisible by the block count, as many full blocks as possible are transferred, followed by a final, partial block transfer. The partial block transfer is for  $n$  sectors, where

$$n = \text{remainder (sector count / block count)}$$

If the Read Multiple command is attempted before the Set Multiple Mode command has been executed or when Read Multiple commands are disabled, the Read Multiple operation is rejected with an Aborted Command error.

Disc errors encountered during Read Multiple commands are posted at the beginning of the block or partial block transfer, but DRQ is still set and the data transfer takes place as it normally would, including transfer of corrupted data, if any.

The contents of the Command Block registers, following the transfer of a data block that had a sector in error, are undefined. The host should retry the transfer as individual requests to obtain valid error information.

Subsequent blocks or partial blocks are transferred only if the error was a correctable data error. All other errors cause the command to stop after transfer of the block that contained the error.

### 3.6.5 Write Multiple command (C5H)

This command (command code C5H) is similar to the Write Sectors command. Interrupts are not presented on each sector but on the transfer of a block that contains the number of sectors defined by Set Multiple Mode command.

The number of sectors per block to be transferred without intervening interrupts is programmed by the Set Multiple Mode command, which must be executed prior to the Write Multiple command.

When the Write Multiple command is issued, the Sector Count register contains the number of sectors (not the number of blocks or the block count) requested.

If the number of requested sectors is not evenly divisible by the block count, as many full blocks as possible are transferred, followed by a final, partial block transfer. The partial block transfer is for  $n$  sectors, where

$$n = \text{remainder (sector count / block count)}$$

If the Write Multiple command is attempted before the Set Multiple Mode command has been executed or when Write Multiple commands are disabled, the Write Multiple operation is rejected with an aborted command error.

Disc errors encountered during Write Multiple commands are posted after the attempted disc write of the block or partial block transferred. The Write command ends with the sector in error, even if it was in the middle of a block. Subsequent blocks are not transferred in the event of an error. Interrupts are generated when DRQ is set to 1 at the beginning of each block or partial block.

The contents of the Command Block registers following the transfer of a data block that had a sector in error are undefined. The host should retry the transfer as individual requests to obtain valid error information.

### 3.7 Onboard drive diagnostics

During startup, the drive executes a series of diagnostic tests. If the diagnostic tests detect an error, the drive LED indicates the nature of the error by emitting a flash code. A subset of the error flash codes are contained in the following table.

<b>Number of flashes</b>	<b>Error code description</b>
Irregular flashes	Microprocessor error
2	ROM checksum error
3	External RAM error
4	I/O chip error
5	Buffer RAM error

### 3.8 ECC performance tests

The drive does not report ECC errors when it performs on-the-fly error correction. This allows the drive to correct the data without sacrificing performance.

Some older drive diagnostic utilities test the drive's ability to apply ECC by creating small data errors and then checking to see if these errors are reported. If you run one of these tests on a drive that is functioning properly, the test may report that the drive is failing to detect ECC errors. However, this does not mean that the drive is malfunctioning.

### 3.9 Supported BIOS

The drive uses 16 bytes of ECC with Read Long and Write Long commands. If the computer BIOS expects 7 ECC bytes, some drive diagnostics may return false failures (typically time-out errors). If so, you must reconfigure the computer to receive 4 bytes of ECC.

The BIOS revisions listed in the following table are fully compatible with the AT interface implemented on the ST3491 family drives. Earlier BIOS revisions than those listed may not fully support the AT interface as implemented on these drives.

<b>BIOS manufacturer</b>	<b>Version supported</b>
American Megatrends	Dated 4/9/90 or later
Award	3.04 or higher
Quadtel	Single drive, any version Dual drive, 3.04 or higher
Phoenix	ROM BIOS Plus 286, 3.10 or higher ROM BIOS Plus 386, 1.10 or higher
PhoenixBIOS	1.00 or higher

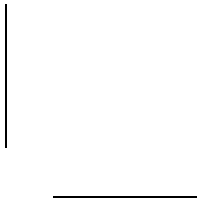
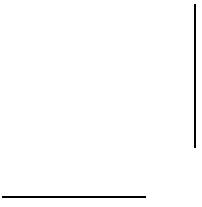

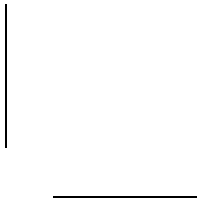
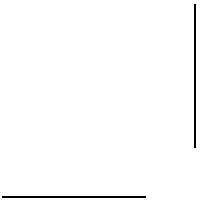



**Seagate Technology, Inc.**

**920 Disc Drive, Scotts Valley, California 95066, USA**

*Publication Number: 36254-004, Rev. B Printed in USA*