



Enterprise NAS HDD

SATA Product Manual

ST8000NE0001

ST6000VN0001

100780707, Rev. C

January 2017

Document Revision History

Revision	Date	Pages affected and Description of changes
Rev. A	11-05-2015	Initial release.
Rev. B	02-11-2016	4-5 & 23-24: Corrected ST models to ST8000NE0001 & ST6000NE0001 5 & 12: Updated Temperatures & Wet Bulb 6 & 15: Revised Rated Workload statement 16: Revised Australian RCM text 19-20: Revised Fastener penetration depth = 0.120 inches in text & Mechanical drawing
Rev. C	01-13-2017	fc, 4-5 & 26-27: Revised model number to - ST8000NE0001 fc, 4-5 & 26-27: Revised model number to - ST6000VN0001 5 & 7: Revised Densities & cache 6 & 14: Revised Nonoperating Vibe to 5.0 Grms 6 & 16: Revised Error rate to 10 [^] 15 & removed [<] from Rated Workload 9: Added Table 3 for 6TB DC power 12: Revised Manufacturer Default Timer Value for Idle_a to 100ms 16: Added MSIP Korean text for Class B device warning 17: Revised to China RoHS2} 21: Added [6TB] to mechanical drawing - Figure 4 22: Added new mechanical drawing - Figure 5 for 8TB drive

© 2017 Seagate Technology LLC. All rights reserved.

Publication number: 100780707, Rev. C January 2017

Seagate, Seagate Technology and the Spiral logo are registered trademarks of Seagate Technology LLC in the United States and/or other countries. Power Choice and SeaTools are either trademarks or registered trademarks of Seagate Technology LLC or one of its affiliated companies in the United States and/or other countries. All other trademarks or registered trademarks are the property of their respective owners.

No part of this publication may be reproduced in any form without written permission of Seagate Technology LLC.

Call 877-PUB-TEK1 (877-782-8351) to request permission.

When referring to drive capacity, one gigabyte, or GB, equals one billion bytes and one terabyte, or TB, equals one trillion bytes. Your computer's operating system may use a different standard of measurement and report a lower capacity. In addition, some of the listed capacity is used for formatting and other functions, and thus will not be available for data storage. Actual quantities will vary based on various factors, including file size, file format, features and application software. Actual data rates may vary depending on operating environment and other factors. The export or re-export of hardware or software containing encryption may be regulated by the U.S. Department of Commerce, Bureau of Industry and Security (for more information, visit www.bis.doc.gov), and controlled for import and use outside of the U.S. Seagate reserves the right to change, without notice, product offerings or specifications.

Contents

Seagate® Technology Support Services	3
---	----------

1.0 Introduction	4
1.1 About the Serial ATA interface	4

2.0 Drive specifications	5
2.1 Specification summary tables	5
2.2 Formatted capacity	7
2.2.1 LBA mode	7
2.3 Recording and interface technology	7
2.4 Start/stop times	7
2.5 Power specifications	8
2.5.1 Power consumption	8
2.5.2 Conducted noise	10
2.5.3 Voltage tolerance	10
2.5.4 Extended Power Conditions - PowerChoice™	11
2.6 Environmental specifications	13
2.6.1 Drive case temperature	13
2.6.2 Temperature	13
2.6.3 Temperature gradient	13
2.6.4 Humidity	13
2.6.5 Altitude	13
2.6.6 Shock	14
2.6.7 Vibration	14
2.7 Acoustics	15
2.8 Test for Prominent Discrete Tones (PDTs)	15
2.9 Electromagnetic immunity	15
2.10 Reliability	16
2.10.1 Annualized Failure Rate (AFR) and Mean Time Between Failures (MTBF)	16
2.11 Agency certification	16
2.11.1 Safety certification	16
2.11.2 Electromagnetic compatibility	16
2.11.3 FCC verification	17
2.12 Environmental protection	18
2.12.1 European Union Restriction of Hazardous Substances (RoHS) Directive	18
2.12.2 China Requirements — China RoHS 2	18
2.12.3 Corrosive environment	18
2.13 Product warranty	19

3.0 Configuring and mounting the drive	20
3.1 Handling and static-discharge precautions	20
3.2 Configuring the drive	20
3.3 Serial ATA cables and connectors	20
3.4 Drive mounting	20
3.4.1 Mechanical specifications	21

4.0 Serial ATA (SATA) interface	23
4.1 Hot-Plug compatibility	23
4.2 Serial ATA device plug connector pin definitions	23
4.3 Supported ATA commands	24
4.3.1 Identify Device command	26
4.3.2 Set Features command	29
4.3.3 S.M.A.R.T. commands	30

Seagate® Technology Support Services

For information regarding online support and services, visit: <http://www.seagate.com/contacts/>

For information regarding Warranty Support, visit: <http://www.seagate.com/support/warranty-and-replacements/>

For information regarding data recovery services, visit: <http://www.seagate.com/services-software/data-recovery-services/>

For Seagate OEM, Distribution partner portal and reseller portal, visit: <http://www.seagate.com/partners>

1.0 Introduction

This manual describes the functional, mechanical and interface specifications for the following: Seagate® Enterprise NAS HDD model drives:

Standard 512e models

ST8000NE0001 & ST6000VN0001

These drives provide the following key features:

- 7200 RPM spindle speed.
- PowerChoice™ for selectable power savings
- Top Cover Attached motor for excellent vibration tolerance
- High instantaneous (burst) data-transfer rates (up to 600MB per second).
- Perpendicular recording technology provides the drives with increased areal density.
- State-of-the-art cache and on-the-fly error-correction algorithms.
- Native Command Queuing with command ordering to increase performance in demanding applications.
- Full-track multiple-sector transfer capability without local processor intervention.
- Compliant with RoHS requirements in China and Europe
- SeaTools™ diagnostic software performs a drive self-test that eliminates unnecessary drive returns.
- Support for S.M.A.R.T. drive monitoring and reporting.
- Supports latching SATA cables and connectors.
- Worldwide Name (WWN) capability uniquely identifies the drive.

1.1 About the Serial ATA interface

The Serial ATA interface provides several advantages over the traditional (parallel) ATA interface. The primary advantages include:

- Easy installation and configuration with true plug-and-play connectivity. It is not necessary to set any jumpers or other configuration options.
- Thinner and more flexible cabling for improved enclosure airflow and ease of installation.
- Scalability to higher performance levels.

In addition, Serial ATA makes the transition from parallel ATA easy by providing legacy software support. Serial ATA was designed to allow users to install a Serial ATA host adapter and Serial ATA disk drive in current systems and expect all existing applications to work as normal.

The Serial ATA interface connects each disk drive in a point-to-point configuration with the Serial ATA host adapter. There is no master/slave relationship with Serial ATA devices like there is with parallel ATA. If two drives are attached on one Serial ATA host adapter, the host operating system views the two devices as if they were both “masters” on two separate ports. This essentially means both drives behave as if they are Device 0 (master) devices.

Note

The host adapter may, optionally, emulate a master/slave environment to host software where two devices on separate Serial ATA ports are represented to host software as a Device 0 (master) and Device 1 (slave) accessed at the same set of host bus addresses. A host adapter that emulates a master/slave environment manages two sets of shadow registers. This is not a typical Serial ATA environment.

The Serial ATA host adapter and drive share the function of emulating parallel ATA device behavior to provide backward compatibility with existing host systems and software. The Command and Control Block registers, PIO and DMA data transfers, resets, and interrupts are all emulated.

The Serial ATA host adapter contains a set of registers that shadow the contents of the traditional device registers, referred to as the Shadow Register Block. All Serial ATA devices behave like Device 0 devices. For additional information about how Serial ATA emulates parallel ATA, refer to the “Serial ATA: High Speed Serialized AT Attachment” specification. The specification can be downloaded from www.serialata.org.

2.0 Drive specifications

Unless otherwise noted, all specifications are measured under ambient conditions, at 25°C, and nominal power. For convenience, the phrases *the drive* and *this drive* are used throughout this manual to indicate the following drive models:

Standard 512e models

ST8000NE0001 & ST6000VN0001

2.1 Specification summary tables

The specifications listed in the following tables are for quick reference. For details on specification measurement or definition, see the appropriate section of this manual.

Table 1 Drive specifications summary

Drive specification	ST8000NE0001	ST6000VN0001
Formatted (512 bytes/sector)*	8TB	6TB
Guaranteed sectors	15,628,053,168	11,721,045,168
Heads	12	
Discs	6	
Bytes per physical sector	4096	
Bytes per logical sector	512	
Recording density, KBPI (Kb/in max)	2241	1981
Track density, KTPI (ktracks/in avg.)	362	320
Areal density, (Gb/in ² avg)	802	633
Spindle speed (RPM)	7200	
Internal data transfer rate (Mb/s max)	2546	2317
Sustained data transfer rate OD (max)	237MiB/s	216MiB/s
I/O data-transfer rate (MB/s max)	600	
ATA data-transfer modes supported	PIO modes 0–4 Multiword DMA modes 0–2 Ultra DMA modes 0–6	
Cache buffer	256MB (259,072KB)	128MB (129,536KB)
Weight: (maximum)	780g (1.72 lb)	
Average latency	4.16ms	
Power-on to ready (sec)	25 (typ) / 30 (max)	
Standby to ready (sec)	25 (typ) / 30 (max)	
Startup current (typical) 12V (peak)	2.0A	
Voltage tolerance (including noise)	5V ±5% 12V ±5%	
Non-Operating temperature (Ambient °C)	–40 to 70	
Operating temperature (Ambient min °C)	5	
Operating temperature (Drive case max °C)	60	
Temperature gradient (per hour max)	20°C (operating) 30°C (nonoperating)	
Relative humidity	5% to 95% (operating) 5% to 95% (nonoperating)	
Relative humidity gradient	30% per hour max	
Wet bulb temperature (max)	26°C (operating) 29°C (nonoperating)	
Altitude, operating	–304.8 m to 3,048 m (–1000 ft to 10,000+ ft)	

Drive specification	ST8000NE0001	ST6000VN0001
Altitude, nonoperating (below mean sea level, max)	-304.8 m to 12,192 m (-1000 ft to 40,000+ ft)	
Operational Shock (max at 2 ms)	Read 70 Gs Write 40 Gs	
Non-Operational Shock (max at 2 ms)	250 Gs	
Vibration, operating	5–22 Hz: 0.25 Gs, Limited displacement 22–350 Hz: 0.50 Gs 350–500 Hz: 0.25 Gs	
Operation Rotational vibration	20–1500Hz: 12.5 rads/s ²	
Vibration, nonoperating	10–500 Hz: 5.0 Grms ref	
Drive acoustics, sound power (bels)		
Idle**	2.8 (typical) 3.0 (max)	
Performance seek	3.0 (typical) 3.4 (max)	
Nonrecoverable read errors	1 sector per 10 ¹⁵ bits read	
Annualized Failure Rate (AFR)	0.73% based on 8760 POH	
Rated Workload	Average annualized workload rating: 300 TB/year. The AFR specification for the product assumes the I/O workload does not exceed the average annualized workload rate limit of 300 TB/year. Workloads exceeding the annualized rate may degrade the product AFR and impact reliability as experienced by the particular application. The average annualized workload rate limit is in units of TB per calendar year.	
Warranty	To determine the warranty for a specific drive, use a web browser to access the following web page: http://www.seagate.com/support/warranty-and-replacements/ . From this page, click on the "Is my Drive under Warranty" link. The following are required to be provided: the drive serial number, model number (or part number) and country of purchase. The system will display the warranty information for the drive.	
Load-unload cycles	300,000	
Supports Hotplug operation per Serial ATA Revision 3.2 specification	Yes	

*One GB equals one billion bytes when referring to hard drive capacity. Accessible capacity may vary depending on operating environment and formatting.

**During periods of drive idle, some offline activity may occur according to the S.M.A.R.T. specification, which may increase acoustic and power to operational levels.

2.2 Formatted capacity

Formatted capacity*	Guaranteed sectors	Bytes per physical sector	Bytes per logical sector
8TB	15,628,053,168	4096	512
6TB	11,721,045,168		

*One GB equals one billion bytes when referring to hard drive capacity. Accessible capacity may vary depending on operating environment and formatting.

2.2.1 LBA mode

When addressing these drives in LBA mode, all blocks (sectors) are consecutively numbered from 0 to $n-1$, where n is the number of guaranteed sectors as defined above.

See [Section 4.3.1, "Identify Device command"](#) (words 60-61 and 100-103) for additional information about 48-bit addressing support of drives with capacities over 137GB.

2.3 Recording and interface technology

	8TB models	6TB models
Interface	Serial ATA (SATA)	
Recording method	Perpendicular	
Recording density, KBPI (Kb/in max)	2241	1981
Track density, KTPI (ktracks/in avg)	362	320
Areal density (Gb/in ² avg)	802	633
Spindle speed (RPM) (\pm 0.2%)	7200	
Internal data transfer rate (Mb/s max)	2546	2317
Sustained data transfer rate (max)	237 MiB/s	216 MiB/s
I/O data-transfer rate (MB/s max)	600 (Ultra DMA mode 5)	

2.4 Start/stop times

Power-on to Ready (sec)	25 (max)
Standby to Ready (sec)	30 (max)
Ready to spindle stop (sec)	12 (max)

2.5 Power specifications

The drive receives DC power (+5V or +12V) through a native SATA power connector. See [Figure 2](#) on [page 20](#).

2.5.1 Power consumption

Power requirements for the drives are listed in the table on page 9. Typical power measurements are based on an average of drives tested, under nominal conditions, using 5.0V and 12.0V input voltage at 25°C ambient temperature.

Table 2 DC power requirements (8TB models)

		6.0Gb mode		
Voltage		+5V	+12V	Watts
Regulation		± 5%		Total
Avg Idle Current *		0.33	0.58	8.63
Advanced Idle Current *				
	Idle_A	0.19	0.55	7.53
	Idle_B	0.13	0.48	6.38
	Idle_C	0.14	0.28	4.08
	Standby_Z	0.12	0.01	0.71
Maximum Start Current				
	DC (peak DC)	0.54	1.91	25.60
	AC (Peak DC)	0.64	2.30	
Delayed Motor Start (DC max)		0.21	0.72	
Peak operating current (random read 4K16Q):				
	Typical DC	0.23	0.64	8.80
	Maximum DC	0.23	0.65	
	Maximum DC (peak)	0.79	2.13	
Peak operating current (random write 4K16Q)				
	Typical DC	0.25	0.66	9.10
	Maximum DC	0.25	0.66	
	Maximum DC (peak)	0.51	2.46	
Peak operating current (sequential read 64K16Q)				
	Typical DC	0.54	0.60	9.84
	Maximum DC	0.54	0.60	
	Maximum DC (peak)	0.86	1.02	
Peak operating current (sequential write 64K16Q)				
	Typical DC	0.45	0.62	9.72
	Maximum DC	0.46	0.62	
	Maximum DC (peak)	0.57	1.03	

*During periods of drive idle, some offline activity may occur according to the S.M.A.R.T. specification, which may increase acoustic and power to operational levels.

Table 3 DC power requirements (6TB models)

		6.0Gb mode		
Voltage		+5V	+12V	Watts
Regulation		± 5%		Total
Avg Idle Current *		0.19	0.59	8.00
Advanced Idle Current *				
	Idle_A	0.14	0.60	7.85
	Idle_B	0.13	0.53	6.97
	Idle_C	0.13	0.31	4.43
	Standby_Z	0.11	0.01	0.67
Maximum Start Current				
	DC (peak DC)	0.37	2.28	29.21
	AC (Peak DC)	0.56	2.95	38.20
Delayed Motor Start (DC max)		0.12	0.01	0.73
Peak operating current (random read 4K16Q):				
	Typical DC	0.22	0.79	10.62
	Maximum DC	0.23	0.84	11.21
	Maximum DC (peak)	1.17	2.31	33.57
Peak operating current (random write 4K16Q)				
	Typical DC	0.22	0.65	8.91
	Maximum DC	0.23	0.70	9.55
	Maximum DC (peak)	1.45	3.08	44.21
Peak operating current (sequential read 64K16Q)				
	Typical DC	0.52	0.64	10.32
	Maximum DC	0.54	0.69	10.98
	Maximum DC (peak)	0.72	1.08	16.56
Peak operating current (sequential write 64K16Q)				
	Typical DC	0.44	0.68	10.35
	Maximum DC	0.46	0.72	10.94
	Maximum DC (peak)	0.60	1.06	15.72

2.5.1.1 Typical current profiles

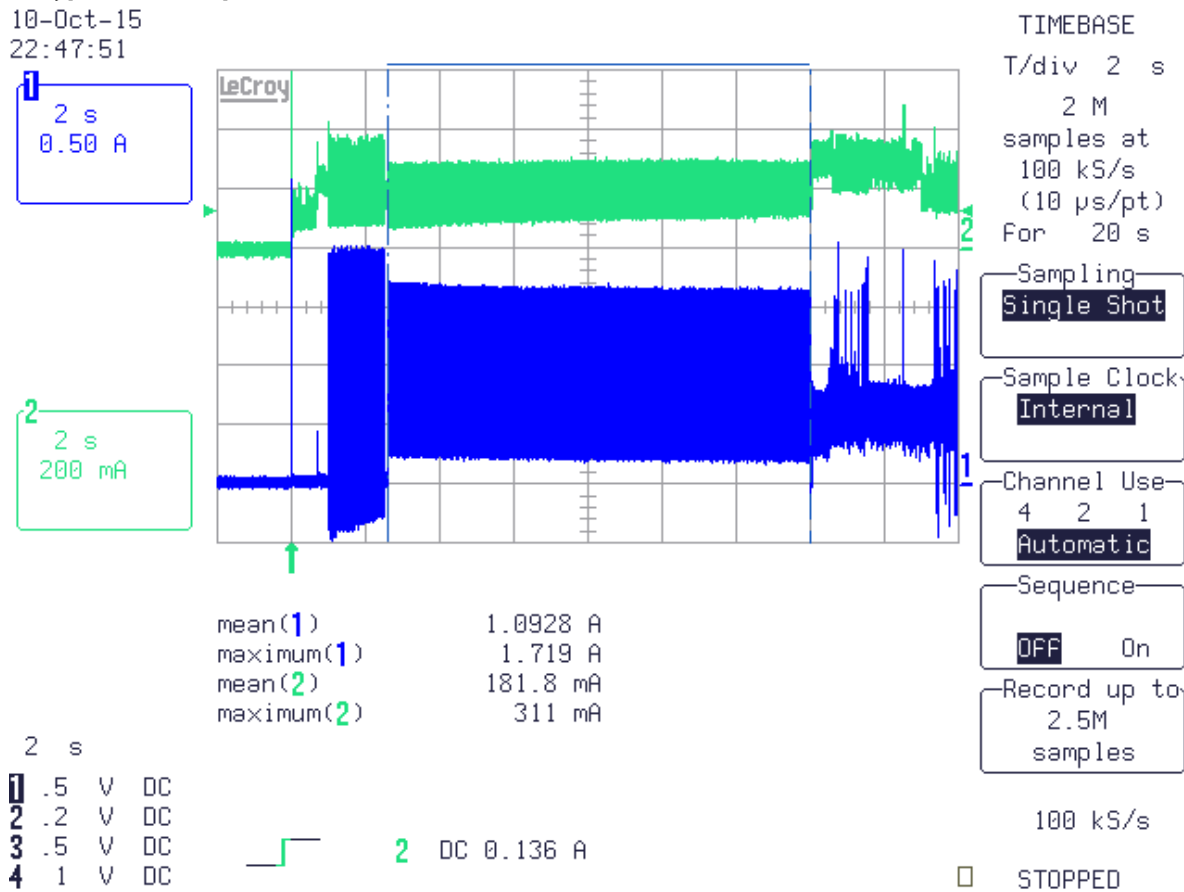

Figure 1. Typical 5V & 12V startup and operation current profile (4TB)

2.5.2 Conducted noise

Input noise ripple is measured at the host system power supply across an equivalent 80-ohm resistive load on the +12 V line or an equivalent 15-ohm resistive load on the +5V line.

- Using 12V power, the drive is expected to operate with a maximum of 120mV peak-to-peak square-wave injected noise at up to 10MHz.
- Using 5V power, the drive is expected to operate with a maximum of 100mV peak-to-peak square-wave injected noise at up to 10MHz.

Note Equivalent resistance is calculated by dividing the nominal voltage by the typical RMS read/write current.

2.5.3 Voltage tolerance

Voltage tolerance (including noise):

- 5V ± 5%
- 12V ± 5%

2.5.4 Extended Power Conditions - PowerChoice™

Utilizing the load/unload architecture a programmable power management interface is provided to tailor systems for reduced power consumption and performance requirements.

The table below lists the supported power conditions available in PowerChoice. Power conditions are ordered from highest power consumption (and shortest recovery time) to lowest power consumption (and longest recovery time) as follows: Idle_a power >= Idle_b power >= Idle_c power >= Standby_z power. The further users go down in the table, the more power savings is actualized. For example, Idle_b results in greater power savings than the Idle_a power condition. Standby results in the greatest power savings.

Power Condition Name	Power Condition ID	Description
Idle_a	81 _H	Reduced electronics
Idle_b	82 _H	Heads unloaded. Disks spinning at full RPM
Idle_c	83 _H	Heads unloaded. Disks spinning at reduced RPM
Standby_z	00 _H	Heads unloaded. Motor stopped (disks not spinning)

Each power condition has a set of current, saved and default settings. Default settings are not modifiable. Default and saved settings persist across power-on resets. The current settings do not persist across power-on resets. At the time of manufacture, the default, saved and current settings are in the Power Conditions log match.

PowerChoice is invoked using one of two methods

- Automatic power transitions which are triggered by expiration of individual power condition timers. These timer values may be customized and enabled using the Extended Power Conditions (EPC) feature set using the standardized Set Features command interface.
- Immediate host commanded power transitions may be initiated using an EPC Set Features "Go to Power Condition" subcommand to enter any supported power condition. Legacy power commands Standby Immediate and Idle Immediate also provide a method to directly transition the drive into supported power conditions.

PowerChoice exits power saving states under the following conditions

- Any command which requires the drive to enter the PM0: Active state (media access)
- Power on reset

PowerChoice provides the following reporting methods for tracking purposes

Check Power Mode Command

- Reports the current power state of the drive

Identify Device Command

- EPC Feature set supported flag
- EPC Feature enabled flag is set if at least one Idle power condition timer is enabled

Power Condition Log reports the following for each power condition

- Nominal recovery time from the power condition to active
- If the power condition is Supported, Changeable, and Savable
- Default enabled state, and timer value
- Saved enabled state, and timer value
- Current enabled state, and timer value

S.M.A.R.T. Read Data Reports

- Attribute 192 - Emergency Retract Count
- Attribute 193 - Load/Unload Cycle Count

PowerChoice Manufacture Default Power Condition Timer Values

Default power condition timer values have been established to assure product reliability and data integrity. A minimum timer value threshold of two minutes ensures the appropriate amount of background drive maintenance activities occur. Attempting to set a timer values less than the specified minimum timer value threshold will result in an aborted EPC "Set Power Condition Timer" subcommand.

Power Condition Name	Manufacturer Default Timer Values
Idle_a	100 ms
Idle_b	2 min
Idle_c	10 min
Standby_z	15 min

Setting power condition timer values less than the manufacturer specified defaults or issuing the EPC "Go to Power Condition" subcommand at a rate exceeding the default timers may limit this products reliability and data integrity.

PowerChoice Supported Extended Power Condition Feature Subcommands

EPC Subcommand	Description
00 _H	Restore Power Condition Settings
01 _H	Go to Power Condition
02 _H	Set Power Condition Timer
03 _H	Set Power Condition State
04 _H	Enable EPC Feature Set
05 _H	Disable EPC Feature Set

PowerChoice Supported Extended Power Condition Identifiers

Power Condition Identifiers	Power Condition Name
00 _H	Standby_z
01 - 80 _H	Reserved
81 _H	Idle_a
82 _H	Idle_b
83 _H	Idle_c
84 - FE _H	Reserved
FF _H	All EPC Power Conditions

2.6 Environmental specifications

This section provides the temperature, humidity, shock, and vibration specifications for NAS HDDs. This section provides the temperature, humidity, shock, and vibration specifications.

2.6.1 Drive case temperature

Ambient temperature is defined as the temperature of the environment immediately surrounding the drive. Above 1000ft. (305 meters), the maximum temperature is derated linearly by 1°C every 1000 ft. Drive case temperature should be measured at the location indicated in [Figure 4](#).

2.6.2 Temperature

Non-Operating (Ambient °C)	-40 to 70
Operating temperature (Ambient min °C)	5
Operating temperature (Drive case max °C)	60

2.6.3 Temperature gradient

Operating	20°C per hour (36°F per hour max), without condensation
Non-operating	30°C per hour (54°F per hour max)

2.6.4 Humidity

2.6.4.1 Relative humidity

Operating	5% to 90% non-condensing (30% per hour max)
Nonoperating	5% to 95% non-condensing (30% per hour max)

2.6.4.2 Wet bulb temperature

Operating	26°C / 78.8°F (rated)
Non-operating	29°C / 84.2°F (rated)

2.6.5 Altitude

Operating	-61m to 3048m (-200 ft. to 10,000 ft.)
Non-operating	-61m to 12,192m (-200 ft. to 40,000+ ft.)

2.6.6 Shock

All shock specifications assume that the drive is mounted securely with the input shock applied at the drive mounting screws. Shock may be applied in the X, Y or Z axis.

2.6.6.1 Operating shock

These drives comply with the performance levels specified in this document when subjected to a maximum operating shock of 70 Gs (read) and 40 Gs (write) based on half-sine shock pulses of 2ms. Shocks should not be repeated more than two times per second.

2.6.6.2 Nonoperating shock

The nonoperating shock level that the drive can experience without incurring physical damage or degradation in performance when subsequently put into operation is 250 Gs based on a nonrepetitive half-sine shock pulse of 2ms duration.

2.6.7 Vibration

All vibration specifications assume that the drive is mounted securely with the input vibration applied at the drive mounting screws. Vibration may be applied in the X, Y or Z axis.

2.6.7.1 Operating vibration

The maximum vibration levels that the drive may experience while meeting the performance standards specified in this document are specified below.

5–22 Hz	0.25 Gs
22–350 Hz	0.50 Gs
350–500 Hz	0.25 Gs
20 - 1500Hz *(RROV)	12.5 rads/s ² w/RVFF

* Rotary Random Operating Vibration

2.6.7.2 Nonoperating vibration

The maximum nonoperating vibration levels that the drive may experience without incurring physical damage or degradation in performance when subsequently put into operation are specified below.

10–500 Hz Linear Random	5.0 Grms ref
----------------------------	--------------

2.7 Acoustics

Drive acoustics are measured as overall A-weighted acoustic sound power levels (no pure tones). All measurements are consistent with ISO document 7779. Sound power measurements are taken under essentially free-field conditions over a reflecting plane. For all tests, the drive is oriented with the cover facing upward.

Note	For seek mode tests, the drive is placed in seek mode only. The number of seeks per second is defined by the following equation: (Number of seeks per second = $0.4 / (\text{average latency} + \text{average access time})$)
-------------	--

Table 4 Fluid Dynamic Bearing (FDB) motor acoustics

	Idle*	Performance seek
All models	2.8 bels (typ) 3.0 bels (max)	3.0 bels (typ) 3.4 bels (max)

*During periods of drive idle, some offline activity may occur according to the S.M.A.R.T. specification, which may increase acoustic and power to operational levels.

2.8 Test for Prominent Discrete Tones (PDTs)

Seagate follows the ECMA-74 standards for measurement and identification of PDTs. An exception to this process is the use of the absolute threshold of hearing. Seagate uses this threshold curve (originated in ISO 389-7) to discern tone audibility and to compensate for the inaudible components of sound prior to computation of tone ratios according to Annex D of the ECMA-74 standards.

2.9 Electromagnetic immunity

When properly installed in a representative host system, the drive operates without errors or degradation in performance when subjected to the radio frequency (RF) environments defined in the following table:

Table 5 Radio frequency environments

Test	Description	Performance level	Reference standard
Electrostatic discharge	Contact, HCP, VCP: ± 4 kV; Air: ± 8 kV	B	EN 61000-4-2: 95
Radiated RF immunity	80 to 1000 MHz, 3 V/m, 80% AM with 1 kHz sine 900 MHz, 3 V/m, 50% pulse modulation @ 200 Hz	A	EN 61000-4-3: 96 ENV 50204: 95
Electrical fast transient	± 1 kV on AC mains, ± 0.5 kV on external I/O	B	EN 61000-4-4: 95
Surge immunity	± 1 kV differential, ± 2 kV common, AC mains	B	EN 61000-4-5: 95
Conducted RF immunity	150 kHz to 80 MHz, 3 Vrms, 80% AM with 1 kHz sine	A	EN 61000-4-6: 97
Voltage dips, interrupts	0% open, 5 seconds 0% short, 5 seconds 40%, 0.10 seconds 70%, 0.01 seconds	C C C B	EN 61000-4-11: 94

2.10 Reliability

2.10.1 Annualized Failure Rate (AFR) and Mean Time Between Failures (MTBF)

The production disk drive shall achieve an annualized failure-rate of 0.73% (MTBF of 1,200,000 hours) over a 5 year service life when used in Enterprise Storage field conditions as limited by the following:

- 8760 power-on hours per year.
- HDA temperature as reported by the drive $\leq 40^{\circ}\text{C}$
- Ambient wet bulb temp $\leq 26^{\circ}\text{C}$
- The AFR (MTBF) is a population statistic not relevant to individual units
- ANSI/ISA S71.04-2013 G2 classification levels and dust contamination to ISO 14644-1 Class 8 standards (as measured at the device)

The MTBF specification for the drive assumes the operating environment is designed to maintain nominal drive temperature and humidity. The rated MTBF is based upon a sustained drive temperature of up to 122°F (40°C) and wet bulb temperature up to 78.8°F (26°C). Occasional excursions in operating conditions between the rated MTBF conditions and the maximum drive operating conditions may occur without significant impact to the rated MTBF. However continual or sustained operation beyond the rated MTBF conditions will degrade the drive MTBF and reduce product reliability.

Nonrecoverable read errors	1 per 10^{15} bits read, max
Annualized Failure Rate (AFR)	0.73% (nominal power, 40°C case temperature)
Load unload cycles	300,000 cycles
Rated Workload	Average annualized workload rating: 300 TB/year. The AFR specification for the product assumes the I/O workload does not exceed the average annualized workload rate limit of 300 TB/year. Workloads exceeding the annualized rate may degrade the product AFR and impact reliability as experienced by the particular application. The average annualized workload rate limit is in units of TB per calendar year.
Warranty	To determine the warranty for a specific drive, use a web browser to access the following web page: http://www.seagate.com/support/warranty-and-replacements/ . From this page, click on the "Is my Drive under Warranty" link. The following are required to be provided: the drive serial number, model number (or part number) and country of purchase. The system will display the warranty information for the drive.
Preventive maintenance	None required.

2.11 Agency certification

2.11.1 Safety certification

These products are certified to meet the requirements of UL60950-1, CSA60950-1 and EN60950 and so marked as to the certify agency.

2.11.2 Electromagnetic compatibility

Hard drives that display the CE mark comply with the European Union (EU) requirements specified in the Electromagnetic Compatibility Directive (2004/108/EC) as put into place 20 July 2007. Testing is performed to the levels specified by the product standards for Information Technology Equipment (ITE). Emission levels are defined by EN 55022, Class B and the immunity levels are defined by EN 55024.

Drives are tested in representative end-user systems. Although CE-marked Seagate drives comply with the directives when used in the test systems, we cannot guarantee that all systems will comply with the directives. The drive is designed for operation inside a properly designed enclosure, with properly shielded I/O cable (if necessary) and terminators on all unused I/O ports. Computer manufacturers and system integrators should confirm EMC compliance and provide CE marking for their products.

Korean RRA

If these drives have the Korean Communications Commission (KCC) logo, they comply with paragraph 1 of Article 11 of the Electromagnetic Compatibility control Regulation and meet the Electromagnetic Compatibility (EMC) Framework requirements of the Radio Research Agency (RRA) Communications Commission, Republic of Korea.

These drives have been tested and comply with the Electromagnetic Interference/Electromagnetic Susceptibility (EMI/EMS) for Class B products. Drives are tested in a representative, end-user system by a Korean-recognized lab.

기종별	사용자안내문
B급 기기 (가정용 방송통신기자재)	이 기기는 가정용(B급) 전자파적합기기로서 주로 가정에서 사용하는 것을 목적으로 하며, 모든 지역에서 사용할 수 있습니다.

Canada ICES-003

If this model has the ICES-003 Marking it complies with the Canadian Standard Association Standard CAN/CSA-CISPR 22-10, Information Technology Equipment - Radio Disturbance Characteristics - Limits and Methods of Measurement.

Australian RCM Compliance Mark

Models displayed with the RCM compliance mark, comply with the mandatory standards as per the Australian Communications and Media Authority (ACMA) Electromagnetic Compatibility (EMC) regulatory arrangement.

2.11.3 FCC verification

These drives are intended to be contained solely within a personal computer or similar enclosure (not attached as an external device). As such, each drive is considered to be a subassembly even when it is individually marketed to the customer. As a subassembly, no Federal Communications Commission verification or certification of the device is required.

Seagate has tested this device in enclosures as described above to ensure that the total assembly (enclosure, disk drive, motherboard, power supply, etc.) does comply with the limits for a Class B computing device, pursuant to Subpart J, Part 15 of the FCC rules. Operation with noncertified assemblies is likely to result in interference to radio and television reception.

Radio and television interference. This equipment generates and uses radio frequency energy and if not installed and used in strict accordance with the manufacturer's instructions, may cause interference to radio and television reception.

This equipment is designed to provide reasonable protection against such interference in a residential installation. However, there is no guarantee that interference will not occur in a particular installation. If this equipment does cause interference to radio or television, which can be determined by turning the equipment on and off, users are encouraged to try one or more of the following corrective measures:

- Reorient the receiving antenna.
- Move the device to one side or the other of the radio or TV.
- Move the device farther away from the radio or TV.
- Plug the computer into a different outlet so that the receiver and computer are on different branch outlets.

If necessary, users should consult a dealer or an experienced radio/television technician for additional suggestions. Users may find helpful the following booklet prepared by the Federal Communications Commission: *How to Identify and Resolve Radio-Television Interference Problems*. This booklet is available from the Superintendent of Documents, U.S. Government Printing Office, Washington, DC 20402. Refer to publication number 004-000-00345-4.

2.12 Environmental protection

Seagate designs its products to meet environmental protection requirements worldwide, including regulations restricting certain chemical substances.

2.12.1 European Union Restriction of Hazardous Substances (RoHS) Directive

The European Union Restriction of Hazardous Substances (RoHS) Directive, restricts the presence of chemical substances, including Lead, Cadmium, Mercury, Hexavalent Chromium, PBB and PBDE, in electronic products, effective July 2006. This drive is manufactured with components and materials that comply with the RoHS Directive.

2.12.2 China Requirements — China RoHS 2

China RoHS 2 refers to the Ministry of Industry and Information Technology Order No. 32, effective July 1, 2016, titled Management Methods for the Restriction of the Use of Hazardous Substances in Electrical and Electronic Products. To comply with China RoHS 2, we determined this product's Environmental Protection Use Period (EPU) to be 20 years in accordance with the *Marking for the Restricted Use of Hazardous Substances in Electronic and Electrical Products*, SJ/T 11364-2014.

中国电器电子产品有害物质限制使用管理办法

(Management Methods for the Restriction of the Use of Hazardous Substances in Electrical and Electronic Products _ China RoHS)

产品中有害物质的名称及含量

(Name and Content of the Hazardous Substances in Product)



Table 6 Hazardous Substances

部件名称 Part Name	有害物质 Hazardous Substances					
	铅 Lead (Pb)	汞 Mercury (Hg)	镉 Cadmium (Cd)	六价铬 Hexavalent Chromium (CF (VI))	多溴联苯 Polybrominated biphenyls (PBB)	多溴二苯醚 Polybrominated diphenyl ethers (PBDE)
印刷电路板组装 PCBA	X	O	O	O	O	O
机壳 Chassis	X	O	O	O	O	O
本表格依据 SJ/T 11364 的规定编制。 This table is prepared in accordance with the provisions of SJ/T 11364-2014 O: 表示该有害物质在该部件所有均质材料中的含量均在 GB/T 26572 规定的限量要求以下。 O: Indicates that the hazardous substance contained in all of the homogeneous materials for this part is below the limit requirement of GB/T26572. X: 表示该有害物质至少在该部件的某一均质材料中的含量超出 GB/T 26572 规定的限量要求。 X: Indicates that the hazardous substance contained in at least one of the homogeneous materials used for this part is above the limit requirement of GB/T26572.						

2.13 Corrosive environment

Seagate electronic drive components pass accelerated corrosion testing equivalent to 10 years exposure to light industrial environments containing sulfurous gases, chlorine and nitric oxide, classes G and H per ASTM B845. However, this accelerated testing cannot duplicate every potential application environment.

Users should use caution exposing any electronic components to uncontrolled chemical pollutants and corrosive chemicals as electronic drive component reliability can be affected by the installation environment. The silver, copper, nickel and gold films used in hard disk drives are especially sensitive to the presence of sulfide, chloride, and nitrate contaminants. Sulfur is found to be the most damaging. Materials used in cabinet fabrication, such as vulcanized rubber, that can outgas corrosive compounds should be minimized or eliminated. The useful life of any electronic equipment may be extended by replacing materials near circuitry with sulfide-free alternatives.

Seagate recommends that data centers be kept clean by monitoring and controlling the dust and gaseous contamination. Gaseous contamination should be within ANSI/ISA S71.04-2013 G2 classification levels (as measured on copper and silver coupons), and dust contamination to ISO 14644-1 Class 8 standards, and MTBF rated conditions as defined in the Annualized Failure Rate (AFR) and Mean Time Between Failure (MTBF) section.

2.14 Product warranty

Beginning on the date of shipment to the customer and continuing for the period specified in the purchase contract, Seagate warrants that each product (including components and subassemblies) that fails to function properly under normal use due to defect in materials or workmanship or due to nonconformance to the applicable specifications will be repaired or replaced, at Seagate's option and at no charge to the customer, if returned by customer at customer's expense to Seagate's designated facility in accordance with Seagate's warranty procedure. Seagate will pay for transporting the repair or replacement item to the customer. For more detailed warranty information, refer to the standard terms and conditions of purchase for Seagate products on the purchase documentation.

The remaining warranty for a particular drive can be determined by calling Seagate Customer Service at 1-800-468-3472. Users can also determine remaining warranty using the Seagate web site (www.seagate.com). The drive serial number is required to determine remaining warranty information.

Shipping

When transporting or shipping a drive, use only a Seagate-approved container. Keep the original box. Seagate approved containers are easily identified by the Seagate Approved Package label. Shipping a drive in a non-approved container voids the drive warranty.

Seagate repair centers may refuse receipt of components improperly packaged or obviously damaged in transit. Contact an authorized Seagate distributor to purchase additional boxes. Seagate recommends shipping by an air-ride carrier experienced in handling computer equipment.

Storage

Maximum storage periods are 180 days within original unopened Seagate shipping package or 60 days unpackaged within the defined non-operating limits (refer to environmental section in this manual). Storage can be extended to 1 year packaged or unpackaged under optimal environmental conditions (25°C, <40% relative humidity non-condensing, and non-corrosive environment). During any storage period the drive non-operational temperature, humidity, wet bulb, atmospheric conditions, shock, vibration, magnetic and electrical field specifications should be followed.

Product repair and return information

Seagate customer service centers are the only facilities authorized to service Seagate drives. Seagate does not sanction any third-party repair facilities. Any unauthorized repair or tampering with the factory seal voids the warranty.

3.0 Configuring and mounting the drive

This section contains the specifications and instructions for configuring and mounting the drive.

3.1 Handling and static-discharge precautions

After unpacking, and before installation, the drive may be exposed to potential handling and electrostatic discharge (ESD) hazards. Observe the following standard handling and static-discharge precautions:

Caution	<ul style="list-style-type: none"> • Before handling the drive, users should put on a grounded wrist strap, or ground frequently by touching the metal chassis of a computer that is plugged into a grounded outlet. Wear a grounded wrist strap throughout the entire installation procedure. • Handle the drive by its edges or frame <i>only</i>. • The drive is extremely fragile—handle it with care. Do not press down on the drive top cover. • Always rest the drive on a padded, antistatic surface until mounted in the computer. • Do not touch the connector pins or the printed circuit board. • Do not remove the factory-installed labels from the drive or cover them with additional labels. Removal voids the warranty. Some factory-installed labels contain information needed to service the drive. Other labels are used to seal out dirt and contamination.
----------------	--

3.2 Configuring the drive

Each drive on the Serial ATA interface connects point-to-point with the Serial ATA host adapter. There is no master/slave relationship because each drive is considered a master in a point-to-point relationship. If two drives are attached on one Serial ATA host adapter, the host operating system views the two devices as if they were both “masters” on two separate ports. Both drives behave as if they are Device 0 (master) devices.

3.3 Serial ATA cables and connectors

The Serial ATA interface cable consists of four conductors in two differential pairs, plus three ground connections. The cable size may be 30 to 26 AWG with a maximum length of one meter (39.37 in). See [Table 7](#) for connector pin definitions. Either end of the SATA signal cable can be attached to the drive or host.

For direct backplane connection, the drive connectors are inserted directly into the host receptacle. The drive and the host receptacle incorporate features that enable the direct connection to be hot pluggable and blind mateable.

For installations which require cables, users can connect the drive as illustrated in [Figure 2](#).

Each cable is keyed to ensure correct orientation. Enterprise NAS HDD drives support latching SATA connectors.

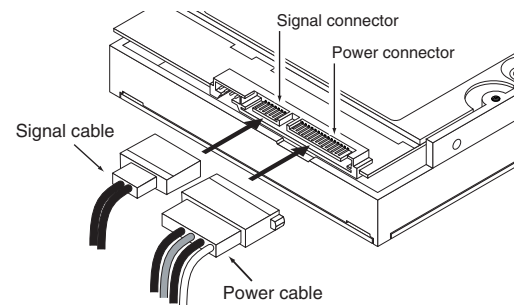

Figure 2. Attaching SATA cabling

3.4 Drive mounting

Users can mount the drive in any orientation using four screws in the side-mounting holes or four screws in the bottom-mounting holes. See [Figure 4](#) for drive mounting dimensions. Follow these important mounting precautions when mounting the drive:

- Allow a minimum clearance of 0.030 in (0.76mm) around the entire perimeter of the drive for cooling.
- Use only 6-32 UNC mounting screws.
- The screws should be inserted no more than 0.120 in (3.05mm) into the bottom or side mounting holes.
- Do not overtighten the mounting screws (maximum torque: 6 in-lb).
- Do not cover breather hole on top cover.

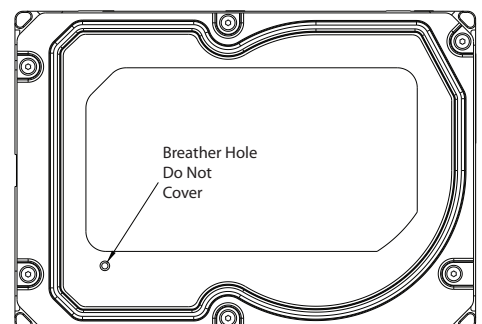

Figure 3. Breather hole location - top cover

3.4.1 Mechanical specifications

Refer to [Figure 4](#) for detailed mounting configuration dimensions. See Section [3.4](#), "Drive mounting."

Weight:	8TB & 6TB models	1.72 lb	780 g
----------------	------------------	---------	-------

Note These dimensions conform to the Small Form Factor Standard documented in SFF-8301 and SFF-8323, found at www.sffcommittee.org

Note The images below are for mechanical tolerance reference only and may not be a visual representation of the actual drive.

4X 6-32 UNC 2B
3 MIN THREAD DEPTH
.12 MAX FASTENER PENETRATION
MOUNTING HOLE.
MAX TORQUE 6 IN/LBS

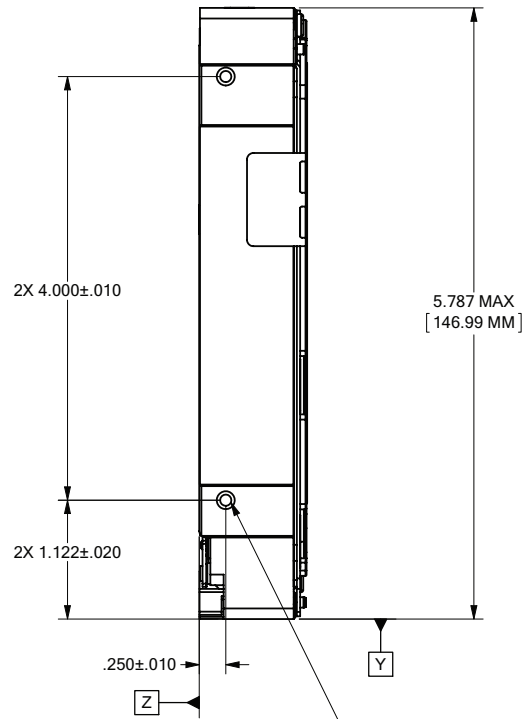
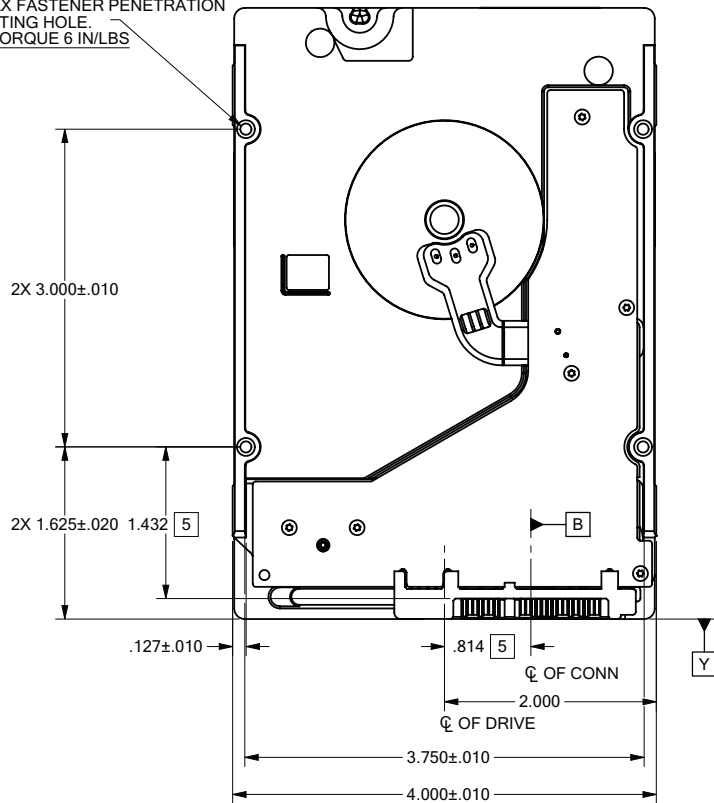

2X 6-32 UNC 2B
3 MIN THREAD DEPTH
.12 MAX FASTENER PENETRATION
MOUNTING HOLES BOTH SIDES.
MAX TORQUE 6 IN/LBS

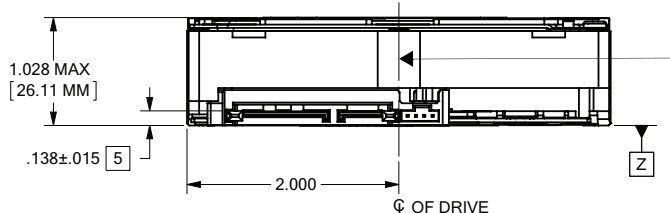

Recommended case temperature measurement location

Figure 4. Mounting dimensions—top, side and end view (6TB)

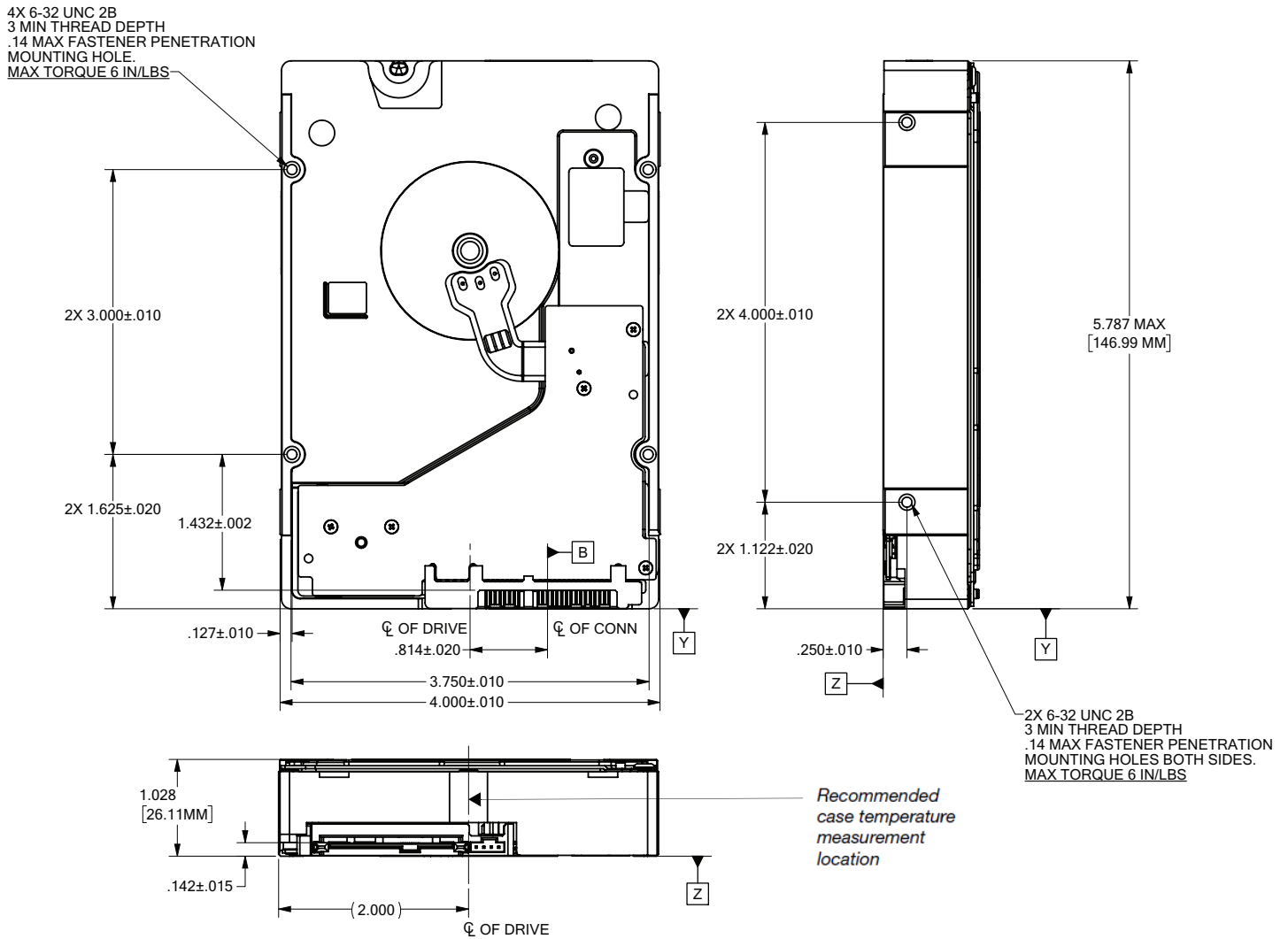

Figure 5. Mounting dimensions—top, side and end view (8TB)

4.0 Serial ATA (SATA) interface

These drives use the industry-standard Serial ATA interface that supports FIS data transfers. It supports ATA programmed input/output (PIO) modes 0–4; multiword DMA modes 0–2, and Ultra DMA modes 0–6.

For detailed information about the Serial ATA interface, refer to the “Serial ATA: High Speed Serialized AT Attachment” specification.

4.1 Hot-Plug compatibility

Enterprise NAS HDD drives incorporate connectors which enable users to hot plug these drives in accordance with the Serial ATA Revision 3.2 specification. This specification can be downloaded from www.serialata.org.

Caution

The drive motor must come to a complete stop (**Ready to spindle stop time indicated in Section 2.4**) prior to changing the plane of operation. This time is required to insure data integrity.

4.2 Serial ATA device plug connector pin definitions

Table 7 summarizes the signals on the Serial ATA interface and power connectors.

Table 7 Serial ATA connector pin definitions

Segment	Pin	Function	Definition
Signal	S1	Ground	2nd mate
	S2	A+	Differential signal pair A from Phy
	S3	A-	
	S4	Ground	2nd mate
	S5	B-	Differential signal pair B from Phy
	S6	B+	
	S7	Ground	2nd mate

Key and spacing separate signal and power segments

Power	P1	V ₃₃	3.3V power
	P2	V ₃₃	3.3V power
	P3	V ₃₃	3.3V power, pre-charge, 2nd mate
	P4	Ground	1st mate
	P5	Ground	2nd mate
	P6	Ground	2nd mate
	P7	V ₅	5V power, pre-charge, 2nd mate
	P8	V ₅	5V power
	P9	V ₅	5V power
	P10	Ground	2nd mate
	P11	Ground or LED signal	If grounded, drive does not use deferred spin
	P12	Ground	1st mate.
	P13	V ₁₂	12V power, pre-charge, 2nd mate
	P14	V ₁₂	12V power
	P15	V ₁₂	12V power

Notes:

1. All pins are in a single row, with a 1.27mm (0.050") pitch.
2. The comments on the mating sequence apply to the case of backplane blindmate connector only. In this case, the mating sequences are:
 - the ground pins P4 and P12.
 - the pre-charge power pins and the other ground pins.
 - the signal pins and the rest of the power pins.
3. There are three power pins for each voltage. One pin from each voltage is used for pre-charge when installed in a blind-mate backplane configuration.
4. All used voltage pins (V_x) must be terminated.

4.3 Supported ATA commands

The following table lists Serial ATA standard commands that the drive supports. For a detailed description of the ATA commands, refer to the Serial ATA: High Speed Serialized AT Attachment specification. See [“S.M.A.R.T. commands” on page 30](#) for details and subcommands used in the S.M.A.R.T. implementation.

Table 8 Supported ATA commands

Command name	Command code (in hex)
Accessible Max Address Configuration	
Get Native Max Address Ext	78 _H / 0000 _H
Set Accessible Max Address Ext	78 _H / 0001 _H
Freeze Accessible Max Address Ext	78 _H / 0002 _H
Check Power Mode	E5 _H
Download Microcode	92 _H
Execute Device Diagnostics	90 _H
Flush Cache	E7 _H
Flush Cache Extended	EA _H
Identify Device	EC _H
Idle	E3 _H
Idle Immediate	E1 _H
NoP	00 _H
Read Buffer	E4 _H
Read Buffer DMA	E9 _H
Read DMA	C8 _H
Read DMA Extended	25 _H
Read FPDMA Queued	60 _H
Read Log DMA Ext	47 _H
Read Log Ext	2F _H
Read Multiple	C4 _H
Read Multiple Extended	29 _H
Read Sectors	20 _H
Read Sectors Extended	24 _H
Read Sectors Without Retries	21 _H
Read Verify Sectors	40 _H
Read Verify Sectors Extended	42 _H

Command name	Command code (in hex)
Read Verify Sectors Without Retries	41 _H
Request Sense Data Ext	0B _H
Sanitize Device - Overwrite Ext	B4 _H / 0014 _H
Sanitize Device - Freeze Lock Ext	B4 _H / 0020 _H
Sanitize Device - Status Ext	B4 _H / 0000 _H
Security Disable Password	F6 _H
Security Erase Prepare	F3 _H
Security Erase Unit	F4 _H
Security Freeze	F5 _H
Security Set Password	F1 _H
Security Unlock	F2 _H
Seek	70 _H
Set Date & Time Ext	77 _H
Set Features	EF _H
Set Multiple Mode	C6 _H
Sleep	E6 _H
S.M.A.R.T. Disable Operations	B0 _H / D9 _H
S.M.A.R.T. Enable/Disable Autosave	B0 _H / D2 _H
S.M.A.R.T. Enable Operations	B0 _H / D8 _H
S.M.A.R.T. Execute Offline	B0 _H / D4 _H
S.M.A.R.T. Read Attribute Thresholds	B0 _H / D1 _H
S.M.A.R.T. Read Data	B0 _H / D0 _H
S.M.A.R.T. Read Log Sector	B0 _H / D5 _H
S.M.A.R.T. Return Status	B0 _H / DA _H
S.M.A.R.T. Save Attribute Values	B0 _H / D3 _H
S.M.A.R.T. Write Log Sector	B0 _H / D6 _H
Standby	E2 _H
Standby Immediate	E0 _H
Write Buffer	E8 _H
Write Buffer DMA	EB _H
Write DMA	CA _H
Write DMA Extended	35 _H
Write DMA FUA Extended	3D _H
Write FPDMA Queued	61 _H
Write Log DMA Ext	57 _H
Write Log Extended	3F _H
Write Multiple	C5 _H
Write Multiple Extended	39 _H
Write Multiple FUA Extended	CE _H
Write Sectors	30 _H
Write Sectors Without Retries	31 _H
Write Sectors Extended	34 _H
Write Uncorrectable	45 _H

4.3.1 Identify Device command

The Identify Device command (command code EC_H) transfers information about the drive to the host following power up. The data is organized as a single 512-byte block of data, whose contents are shown in [Table 8](#) on [page 24](#). All reserved bits or words should be set to zero. Parameters listed with an “x” are drive-specific or vary with the state of the drive. [See Section 2.0](#) on [page 5](#) for default parameter settings.

The following commands contain drive-specific features that may not be included in the Serial ATA specification.

Word	Description	Value
0	Configuration information: • Bit 15: 0 = ATA; 1 = ATAPI • Bit 14-8: Retired • Bit 7-6: Obsolete • Bit 5-3: Retired • Bit 0: Reserved	0C5A _H
1	Number of logical cylinders	16,383
2	Specific Configuration	C837 _H
3	Number of logical heads	16
4	Retired	0000 _H
5	Retired	0000 _H
6	Number of logical sectors per logical track: 63	003F _H
7-9	Retired	0000 _H
10-19	Serial number: (20 ASCII characters, 0000 _H = none)	ASCII
20	Retired	0000 _H
21	Retired	0000 _H
22	Obsolete	0000 _H
23-26	Firmware revision (8 ASCII character string, padded with blanks to end of string)	x.xx
27-46	Drive model number: (40 ASCII characters, padded with blanks to end of string)	
47	(Bits 7-0) Maximum sectors per interrupt on Read multiple and Write multiple (16)	8010 _H
48	Trusted computing feature set options	4000 _H
49	Standard Standby timer, IORDY supported and may be disabled	2F00 _H
50	Capabilities	4000 _H
51	PIO data-transfer cycle timing mode	0200 _H
52	Obsolete	0200 _H
53	Words 64-70 and 88 are valid	0007 _H
54	Number of current logical cylinders	xxxx _H
55	Number of current logical heads	xxxx _H
56	Number of current logical sectors per logical track	xxxx _H
57-58	Current capacity in sectors	xxxx _H
59	Number of sectors transferred during a Read Multiple or Write Multiple command	5D10 _H
60-61	Total number of user-addressable LBA sectors available (see Section 2.2 for related information) *Note: The maximum value allowed in this field is: 0FFFFFFFh (268,435,455 sectors, 137GB). Drives with capacities over 137GB will have 0FFFFFFFh in this field and the actual number of user-addressable LBAs specified in words 100-103. This is required for drives that support the 48-bit addressing feature.	ST8000NE0001 = 0FFFFFFFh* ST6000VN0001 = 0FFFFFFFh*
62	Retired	0000 _H
63	Multiword DMA active and modes supported (see note following this table)	xx07 _H

Word	Description	Value
64	Advanced PIO modes supported (modes 3 and 4 supported)	0003 _H
65	Minimum multiword DMA transfer cycle time per word (120 ns)	0078 _H
66	Recommended multiword DMA transfer cycle time per word (120 ns)	0078 _H
67	Minimum PIO cycle time without IORDY flow control (240 ns)	0078 _H
68	Minimum PIO cycle time with IORDY flow control (120 ns)	0078 _H
69	Additional supported	0008 _H
70–74	ATA-reserved	0000 _H
75	Queue depth	001F _H
76	Serial ATA capabilities	8D0E _H
77	Serial ATA Additional Capabilities	004x _H
78	Serial ATA features supported	08CC _H
79	Serial ATA features enabled	0040 _H
80	Major version number	07F0 _H
81	Minor version number	0000 _H
82	Command sets supported	306B _H
83	Command sets supported	7561 _H
84	Command sets support extension (see note following this table)	6173 _H
85	Command sets enabled	3069 _H
86	Command sets enabled	B441 _H
87	Command sets enable extension	6173 _H
88	Ultra DMA support and current mode (see note following this table)	xx7F _H
89	Security erase time	xxxx _H
90	Enhanced security erase time	xxxx _H
92	Master password revision code	FFFE _H
93	Hardware reset value	xxxx _H
95	ATA-reserved	1000 _H
96–97	ATA-reserved	0000 _H
98–99	ATA-reserved	0000-2710 _H
100–103	Total number of user-addressable LBA sectors available (see Section 2.2 for related information). These words are required for drives that support the 48-bit addressing feature. Maximum value: 0000FFFFFFFFFh.	ST8000NE0001 = 15,628,053,168 ST6000VN0001 = 11,721,045,168
104–105	ATA-reserved	0000 _H
106	Physical/Logical sector size	6003 _H
107	ATA-reserved	0000 _H
108–111	The mandatory value of the world wide name (WWN) for the drive. NOTE: This field is valid if word 84, bit 8 is set to 1 indicating 64-bit WWN support.	Each drive will have a unique value.
112–118	ATA-reserved	0000 _H
119	Commands and feature sets supported	41DE _H
120	Commands and feature sets supported or enabled	40DC _H
121–127	ATA-reserved	0000 _H
128	Security status	0021 _H
129–159	Seagate-reserved	xxxx _H

Word	Description	Value
160–205	ATA-reserved	0000 _H
206	SCT Command Transport command set. If bit 0 is set to one, then the device supports SCT Command Transport. Bits 7:2 indicate individual SCT feature support.	xxBD _H
207-216	ATA-reserved	0000 _H
217	Nominal Media Rotation Rate	1C20 _H
218-221	ATA-reserved	0000 _H
222	Transport Major Version Number	107F _H
223-254	ATA-reserved	0000 _H
255	Integrity word	xxA5 _H

Note See the bit descriptions below for words 63, 84, and 88 of the Identify Drive data.

Description (if bit is set to 1)

Bit	Word 63
0	Multiword DMA mode 0 is supported.
1	Multiword DMA mode 1 is supported.
2	Multiword DMA mode 2 is supported.
8	Multiword DMA mode 0 is currently active.
9	Multiword DMA mode 1 is currently active.
10	Multiword DMA mode 2 is currently active.
Bit	Word 84
0	SMART error logging is supported.
1	SMART self-test is supported.
2	Media serial number is supported.
3	Media Card Pass Through Command feature set is supported.
4	Streaming feature set is supported.
5	GPL feature set is supported.
6	WRITE DMA FUA EXT and WRITE MULTIPLE FUA EXT commands are supported.
7	WRITE DMA QUEUED FUA EXT command is supported.
8	64-bit World Wide Name is supported.
9-10	Obsolete.
11-12	Reserved for TLC.
13	IDLE IMMEDIATE command with IUNLOAD feature is supported.
14	Shall be set to 1.
15	Shall be cleared to 0.
Bit	Word 88
0	Ultra DMA mode 0 is supported.
1	Ultra DMA mode 1 is supported.
2	Ultra DMA mode 2 is supported.
3	Ultra DMA mode 3 is supported.
4	Ultra DMA mode 4 is supported.
5	Ultra DMA mode 5 is supported.

6	Ultra DMA mode 6 is supported.
8	Ultra DMA mode 0 is currently active.
9	Ultra DMA mode 1 is currently active.
10	Ultra DMA mode 2 is currently active.
11	Ultra DMA mode 3 is currently active.
12	Ultra DMA mode 4 is currently active.
13	Ultra DMA mode 5 is currently active.
14	Ultra DMA mode 6 is currently active.

4.3.2 Set Features command

This command controls the implementation of various features that the drive supports. When the drive receives this command, it sets BSY, checks the contents of the Features register, clears BSY and generates an interrupt. If the value in the register does not represent a feature that the drive supports, the command is aborted. Power-on default has the read look-ahead and write caching features enabled. The acceptable values for the Features register are defined as follows

Table 9 Set Features command values

02 _H	Enable write cache (<i>default</i>).
03 _H	Set transfer mode (based on value in Sector Count register). Sector Count register values:
00 _H	Set PIO mode to default (PIO mode 2).
01 _H	Set PIO mode to default and disable IORDY (PIO mode 2).
08 _H	PIO mode 0
09 _H	PIO mode 1
0A _H	PIO mode 2
0B _H	PIO mode 3
0C _H	PIO mode 4 (<i>default</i>)
20 _H	Multiword DMA mode 0
21 _H	Multiword DMA mode 1
22 _H	Multiword DMA mode 2
40 _H	Ultra DMA mode 0
41 _H	Ultra DMA mode 1
42 _H	Ultra DMA mode 2
43 _H	Ultra DMA mode 3
44 _H	Ultra DMA mode 4
45 _H	Ultra DMA mode 5
46 _H	Ultra DMA mode 6
10 _H	Enable use of SATA features
55 _H	Disable read look-ahead (read cache) feature.
82 _H	Disable write cache
90 _H	Disable use of SATA features
AA _H	Enable read look-ahead (read cache) feature (<i>default</i>).
F1 _H	Report full capacity available

Note At power-on, or after a hardware or software reset, the default values of the features are as indicated above.

4.3.3 S.M.A.R.T. commands

S.M.A.R.T. provides near-term failure prediction for disk drives. When S.M.A.R.T. is enabled, the drive monitors predetermined drive attributes that are susceptible to degradation over time. If self-monitoring determines that a failure is likely, S.M.A.R.T. makes a status report available to the host. Not all failures are predictable. S.M.A.R.T. predictability is limited to the attributes the drive can monitor. For more information on S.M.A.R.T. commands and implementation, see the *Draft ATA-5 Standard*.

SeaTools diagnostic software activates a built-in drive self-test (DST S.M.A.R.T. command for D4_H) that eliminates unnecessary drive returns. The diagnostic software ships with all new drives and is also available at:

<http://www.seagate.com/support/downloads/seatools/>.

This drive is shipped with S.M.A.R.T. features disabled. Users must have a recent BIOS or software package that supports S.M.A.R.T. to enable this feature. The table below shows the S.M.A.R.T. command codes that the drive uses.

Table 10 S.M.A.R.T. commands

Code in features register	S.M.A.R.T. command
D0 _H	S.M.A.R.T. Read Data
D2 _H	S.M.A.R.T. Enable/Disable Attribute Autosave
D3 _H	S.M.A.R.T. Save Attribute Values
D4 _H	S.M.A.R.T. Execute Off-line Immediate (runs DST)
D5 _H	S.M.A.R.T. Read Log Sector
D6 _H	S.M.A.R.T. Write Log Sector
D8 _H	S.M.A.R.T. Enable Operations
D9 _H	S.M.A.R.T. Disable Operations
DA _H	S.M.A.R.T. Return Status

Note

If an appropriate code is not written to the Features Register, the command is aborted and 0x04 (abort) is written to the Error register.



Seagate Technology LLC

AMERICAS Seagate Technology LLC 10200 South De Anza Boulevard, Cupertino, California 95014, United States, 408-658-1000

ASIA/PACIFIC Seagate Singapore International Headquarters Pte. Ltd. 7000 Ang Mo Kio Avenue 5, Singapore 569877, 65-6485-3888

EUROPE, MIDDLE EAST AND AFRICA Seagate Technology SAS 16-18 rue du Dôme, 92100 Boulogne-Billancourt, France, 33 1-4186 10 00

*Publication Number: 100780707, Rev. C
January 2017*