

NAS 1 Bay PANAM  
 Part Number: 100710040  
 Folded Size: 120mm W x 150mm H  
 Trim Size: mm 600W X 150mm H  
 Colors: 2C/2C

 NAS Blue  
 K

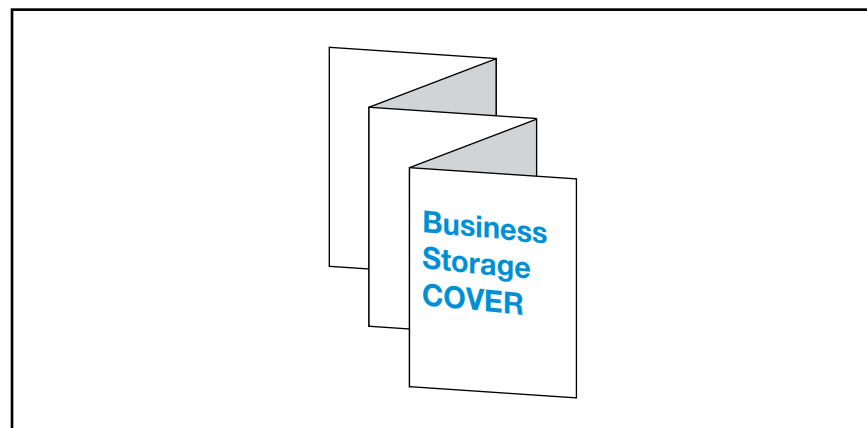

# 1 Bay PANAM

1

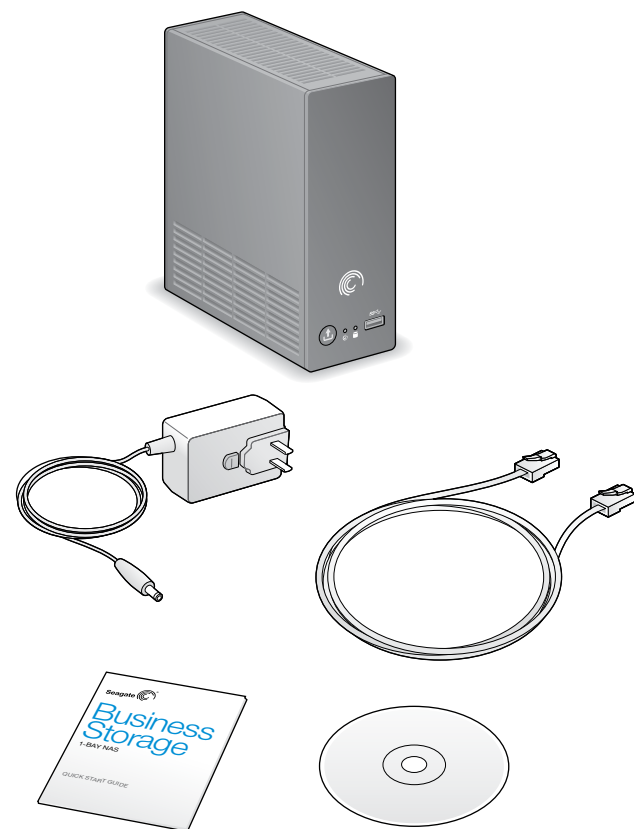

2

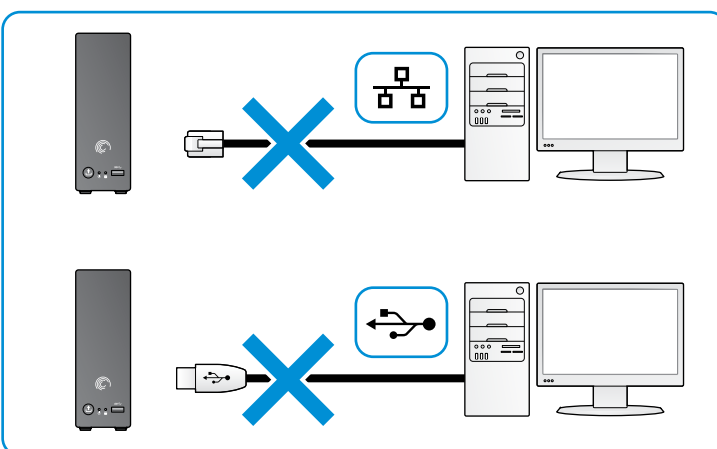
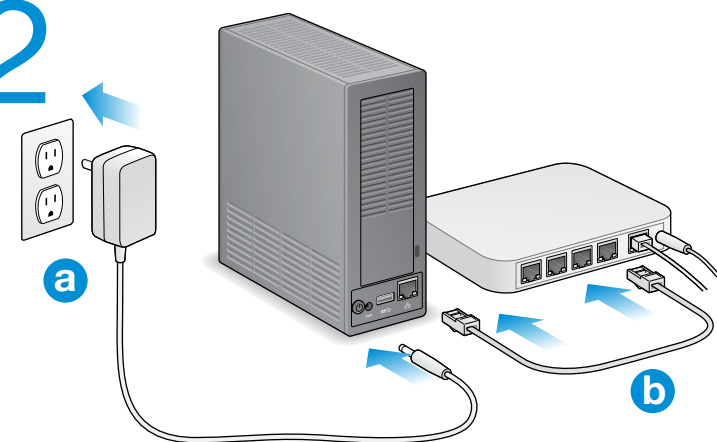

3

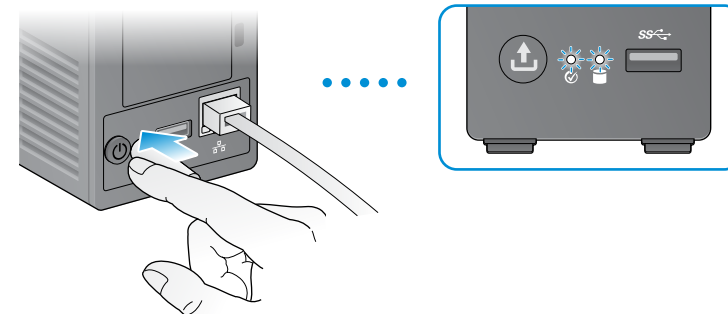

4

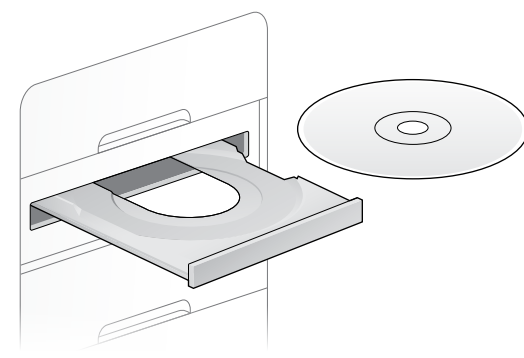

- EN**
1. Unpack the box.
  2. Connect the Seagate NAS.
    - a. Connect the power adapter from the Seagate NAS to a power outlet.
    - b. Connect the Ethernet cable from the Seagate NAS to your router.

**NOTE:** Do not connect the Seagate NAS directly to your computer; connect the computer through a router to the Seagate NAS.

3. Press the power button on the Seagate NAS. Wait for the LEDs on the front panel to stop blinking. This may take a couple of minutes.
4. Insert the DVD. Follow the on-screen instructions to complete the setup.

- FR**
1. Déballez le produit.
  2. Connectez le serveur NAS Seagate.
    - a. Branchez le cordon d'alimentation du serveur NAS Seagate sur une prise de courant.
    - b. Connectez le câble Ethernet du serveur NAS Seagate à votre routeur.

**REMARQUE :** Ne connectez pas le serveur NAS Seagate directement à votre ordinateur. Utilisez votre routeur comme intermédiaire entre votre ordinateur et le serveur NAS.

3. Appuyez sur le bouton de marche/arrêt du serveur NAS Seagate. Attendez que les voyants du panneau avant cessent de clignoter. Cela peut prendre quelques minutes.
4. Insérez le DVD. Suivez les instructions à l'écran pour terminer l'installation.

- ES**
1. Desembale la caja.
  2. Conecte Seagate NAS.
    - a. Conecte el adaptador de corriente desde Seagate NAS a un tomacorriente.
    - b. Conecte el cable Ethernet desde Seagate NAS al enrutador.

**NOTA:** No conecte Seagate NAS directamente a la computadora; conecte la computadora a Seagate NAS mediante un enrutador.

3. Presione el botón de encendido de Seagate NAS. Espere hasta que los indicadores LED en el panel frontal terminen de parpadear. Esto puede demorar algunos minutos.
4. Inserte el DVD. Siga las instrucciones en pantalla para completar la configuración.

**EN** [WWW.SEAGATE.COM](http://WWW.SEAGATE.COM)

Visit us at our Support pages for assistance with:

- **Installation:** Additional instructions and troubleshooting assistance
- **Warranty Information**

To contact support, visit us at our **Contact Us** page.

**NOTE:** To protect your data, always follow the safe removal procedures for your operating system when disconnecting your product.

**FCC DECLARATION OF CONFORMANCE**

This device complies with Part 15 of the FCC Rules. Operation is subject to the following two conditions: (1) this device may not cause harmful interference, and (2) this device must accept any interference received, including interference that may cause undesired operation.

**CLASS B**

This equipment has been tested and found to comply with the limits for a Class B digital device, pursuant to Part 15 of the FCC Rules. These limits are designed to provide reasonable protection against harmful interference in residential installation. This equipment generates, uses, and can radiate radio frequency energy and, if not installed and used in accordance with the instructions, may cause harmful interference to radio communications.

However, there is no guarantee that interference will not occur in a particular installation. If this equipment does cause harmful interference to radio or television reception, which can be determined by turning the equipment off and on, the user is encouraged to try to correct the interference by one or more of the following measures:

- Reorient or relocate the receiving antenna.
- Increase the separation between the equipment and receiver.
- Connect the equipment into an outlet on a circuit different from that to which the receiver is connected.

- Consult the dealer or an experienced radio/TV technician for help.

**CAUTION:** Any changes or modifications made to this equipment may void the user's authority to operate this equipment.

**FR** [WWW.SEAGATE.COM](http://WWW.SEAGATE.COM)

Consultez les pages de support technique de notre site pour toute question relative aux points suivants :

- **Installation :** Instructions supplémentaires et assistance dépannage
- **Informations sur la garantie**

Pour contacter le support technique, consultez la page **Nous contacter**.

**REMARQUE :** Pour protéger vos données, suivez toujours les procédures de retrait sécurisé correspondant à votre système d'exploitation lors de la déconnexion du produit.

**ES** [WWW.SEAGATE.COM](http://WWW.SEAGATE.COM)

Consulte nuestras páginas de asistencia técnica para recibir ayuda sobre:

- **Instalación:** Instrucciones adicionales y asistencia para la resolución de problemas
- **Información de garantías**

Para ponerse en contacto con el servicio de asistencia técnica, consulte nuestra página **Contacto**.

**NOTA:** Para proteger sus datos, asegúrese de seguir los procedimientos de extracción segura de su sistema operativo siempre que desconecte el producto.



100710040

© 2012 Seagate Technology LLC. All rights reserved. Seagate, Seagate Technology, and the Wave logo are trademarks or registered trademarks of Seagate Technology LLC or one of its affiliated companies in the United States and/or other countries. All other trademarks or registered trademarks are the property of their respective owners. When referring to hard drive capacity, one gigabyte, or GB, equals one billion bytes and one terabyte, or TB, equals one thousand billion bytes. Your computer's operating system may use a different standard of measurement and report a lower capacity. In addition, some of the listed capacity is used for formatting and other functions and will not be available for data storage. The export or re-export of hardware or software containing encryption may be regulated by the U.S. Department of Commerce, Bureau of Industry and Security (for more information, visit [www.bis.doc.gov](http://www.bis.doc.gov)). Seagate reserves the right to change, without notice, product offerings or specifications.

Seagate Technology LLC  
 10200 S. De Anza Blvd.  
 Cupertino, CA 95014  
 U.S.A.

PN: 100710040 06/12



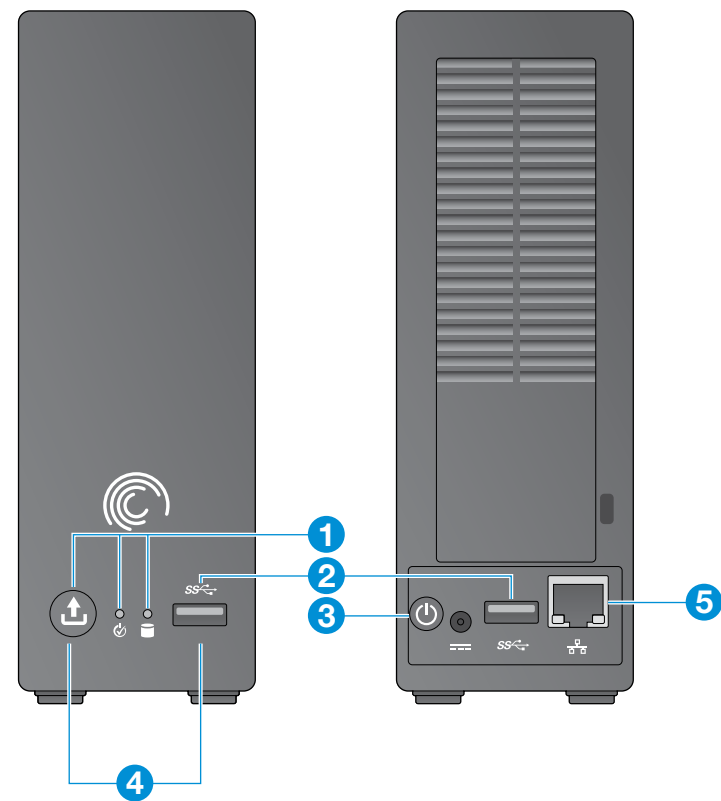

Seagate



EN

### 1 LED Signals

The LEDs on the front and back of your Seagate NAS indicate server status and OneTouch® Transfer activity, as described in this table:

LED	State	Indication	Action to Take
OneTouch Transfer 	Solid blue button	Ready for transfer; transfer complete.	No action required.
	Blinking blue	Transfer in progress.	Wait until the LED stops blinking before removing the USB storage.
	Amber	Error	Contact Seagate Support.
System Status 	Solid blue button	NAS is powered on and ready for use.	No action required.
	Blinking blue	NAS is powering on.	Wait until the LED stops blinking before accessing the NAS.
	Solid amber	NAS has a system or hard drive error.	Contact Seagate Support.
Hard Drive Status 	Solid blue	Power on, drive is ready.	No action required.
	Blinking blue	Drive activity.	No action required.
	Solid amber	Drive error.	Contact Seagate Support.

### 2 USB 3.0 Ports

Your Seagate NAS has two USB 3.0 ports. The ports are backwards compatible with USB 2.0 devices. The ports also support the OneTouch Transfer feature.

### 3 Power Button

The power button is located on the rear panel of the Seagate NAS.

### 4 OneTouch Transfer Button

The OneTouch Transfer feature makes it easy to transfer data to or from a USB slot and your Seagate NAS. Simply press the OneTouch Transfer button on the front of your device and the contents are automatically transferred. See the online Help for information on how to set up transfers.

### 5 Ethernet Port



Your Seagate NAS has one Ethernet port for connecting to your local network.

If you have more questions, review the Help and documentation provided with your Seagate NAS.

FR

### 1 Voyants

Les voyants situés à l'avant et à l'arrière du serveur NAS Seagate indiquent l'état du serveur et des transferts OneTouch®, comme décrit dans le tableau suivant :

Voyant	État	Signification	Action
Transfert OneTouch 	Bleu fixe	Système prêt pour le transfert. Transfert terminé.	Aucune action requise.
	Bleu clignotant	Transfert en cours.	Attendez que le voyant s'arrête de clignoter avant de retirer le stockage USB.
	Orange	Erreur.	Contactez le support Seagate.
État du système 	Bleu fixe	Le serveur NAS est allumé et prêt à être utilisé.	Aucune action requise.
	Bleu clignotant	Le serveur NAS est en cours de démarrage.	Attendez que le voyant s'arrête de clignoter avant d'accéder au serveur NAS.
	Orange fixe	Le serveur NAS a détecté une erreur système ou de disque dur.	Contactez le support Seagate.
État des disques durs 	Bleu fixe	Le disque est allumé et prêt à être utilisé.	Aucune action requise.
	Bleu clignotant	Activité des disques.	Aucune action requise.
	Orange fixe	Erreur de disque.	Contactez le support Seagate.

### 2 Ports USB 3.0

Votre serveur NAS Seagate est doté de deux ports USB 3.0. Ces ports sont rétrocompatibles avec les appareils USB 2.0. Ils sont également compatibles avec la fonction de transfert OneTouch.

### 3 Bouton de marche/arrêt

Le bouton de marche/arrêt se trouve sur le panneau arrière du serveur NAS Seagate.

### 4 Bouton de transfert OneTouch

La fonction de transfert OneTouch permet de transférer facilement des données entre un emplacement USB et votre serveur NAS Seagate. Il suffit d'appuyer sur le bouton OneTouch qui se trouve à l'avant de votre appareil et le contenu est automatiquement transféré. Consultez l'aide en ligne pour savoir comment configurer un transfert.

### 5 Port Ethernet



Votre serveur NAS Seagate est doté d'un port Ethernet pour la connexion à votre réseau local.

Pour toute question, consultez l'aide et la documentation fournies avec votre serveur NAS Seagate.

ES

### 1 Indicadores LED

Los indicadores LED en las partes frontal y posterior de Seagate NAS indican el estado del servidor y la actividad de la transferencia OneTouch®, tal como se describe en la siguiente tabla:

LED	Estado	Interpretación	Medidas por tomar
Transferencia OneTouch 	Botón azul sólido	Listo para la transferencia; transferencia finalizada.	No es necesario tomar medidas.
	La luz azul parpadea	Transferencia en progreso.	Espere a que el LED termine de parpadear para quitar el dispositivo USB.
	Ámbar	Error	Comuníquese con el Soporte de Seagate.
Estado del sistema 	Botón azul sólido	NAS está encendido y listo para su uso.	No es necesario tomar medidas.
	La luz azul parpadea	NAS se está encendiendo.	Espere a que el indicador LED termine de parpadear para acceder a NAS.
	Ámbar sólido	Existe un error en el sistema o unidad de disco duro de NAS.	Comuníquese con el Soporte de Seagate.
Estado de las unidades de disco duro 	Azul sólido	Encendido. La unidad está lista.	No es necesario tomar medidas.
	La luz azul parpadea	Actividad de la unidad.	No es necesario tomar medidas.
	Ámbar sólido	Error en la unidad.	Comuníquese con el Soporte de Seagate.

### 2 Puertos USB 3.0

Seagate NAS posee dos puertos USB 3.0. Los puertos son compatibles con dispositivos anteriores con puertos USB 2.0. Además, los puertos poseen la función de transferencia OneTouch.

### 3 Botón de encendido

El botón de encendido se encuentra ubicado en el panel posterior de Seagate NAS.

### 4 Botón de transferencia OneTouch

La función de transferencia OneTouch facilita la transferencia de datos desde o a una ranura USB y Seagate NAS. Simplemente presione el botón de transferencia OneTouch ubicado en la parte frontal del dispositivo y los contenidos se transferirán automáticamente. Consulte la Ayuda en línea para obtener información sobre cómo configurar las transferencias.

### 5 Puerto Ethernet

Seagate NAS posee un puerto Ethernet para efectuar la conexión a la red local.

Si tiene preguntas adicionales, consulte la sección de Ayuda y la documentación proporcionada con Seagate NAS.



# Business Storage

1-BAY NAS  
FR\_2-BAY NAS

QUICK START GUIDE  
GUIDE DE DÉMARRAGE RAPIDE  
GUÍA DE INICIO RÁPIDO