



# Lyve Mobile Link User Manual



**Hier klicken, um eine aktuelle Online-Version** dieses Dokuments aufzurufen. Auch finden Sie hier die aktuellsten Inhalte sowie erweiterbare Illustrationen, eine übersichtlichere Navigation sowie Suchfunktionen.

# Contents

|          |  |           |
|----------|--|-----------|
| <b>1</b> | <b>Welcome to Lyve Mobile Link</b>               | <b>5</b>  |
|          | Parts list                                       | 5         |
|          | Views  | 6         |
|          | • Front  | 6         |
|          | • Rear   | 6         |
|          | Product dimensions                               | 7         |
| <b>2</b> | <b>Specifications</b>                            | <b>9</b>  |
|          | Network specifications                           | 9         |
|          | Lyve Mobile Arrays connected to Lyve Mobile Link | 9         |
|          | Lyve Mobile Arrays connected to other hosts      | 10        |
|          | Link web app                                     | 10        |
| <b>3</b> | <b>Connection Types</b>                          | <b>12</b> |
|          | Data connection to Link                          | 12        |
|          | Management connection to Link                    | 12        |
|          | Data/management connections to network           | 13        |
|          | Appliance management connection                  | 14        |
| <b>4</b> | <b>Overview of Lyve Mobile Link Setup</b>        | <b>15</b> |
|          | Lyve Mobile Array volume formatting              | 15        |
| <b>5</b> | <b>Pre-Setup: Lyve Hardware and Software</b>     | <b>16</b> |
|          | Lyve software / hardware solutions               | 16        |
| <b>6</b> | <b>Lyve Token Files</b>                          | <b>19</b> |
|          | Sign in to the Link web app                      | 19        |
|          | Authorize Lyve Mobile Arrays connected to Link   | 19        |
|          | USB drive as physical key                        | 19        |
|          | Token file delivery                              | 20        |
| <b>7</b> | <b>Connect Devices</b>                           | <b>22</b> |
|          | Step 1 – Data path                               | 22        |
|          | • PCIe Adapter                                   | 22        |
|          | • Rackmount Receiver                             | 22        |
|          | Step 2 – Management path                         | 23        |
|          | • PCIe Adapter                                   | 23        |
|          | • Rackmount Receiver                             | 24        |
|          | Step 3 – Local network                           | 24        |
|          | Step 4 – Power                                   | 25        |
|          | Step 5 – Power on connected Lyve Mobile Arrays   | 26        |

|           |   |           |
|-----------|---|-----------|
| <b>8</b>  | <b>Get Started with the Link Web App</b>        | <b>27</b> |
|           | Link web app and other Lyve software            | 27        |
|           | Open the Link web app                           | 27        |
|           | • Windows                                       | 27        |
|           | • Linux and macOS                               | 27        |
|           | Sign in with a Lyve Token file                  | 27        |
| <br>      |   |           |
| <b>9</b>  | <b>View Device Info</b>                         | <b>29</b> |
|           | Device info                                     | 29        |
|           | Ethernet port info                              | 29        |
| <br>      |   |           |
| <b>10</b> | <b>Manage Devices</b>                           | <b>31</b> |
|           | View Lyve Mobile Arrays                         | 31        |
|           | • Lyve Mobile Array States                      | 31        |
|           | • Actions in progress                           | 33        |
|           | Authorize devices                               | 34        |
|           | Unlock/mount devices manually to publish shares | 34        |
|           | Eject devices                                   | 34        |
|           | Add other devices                               | 35        |
|           | Forget disconnected devices                     | 35        |
|           | Inspect devices                                 | 35        |
|           | RAID levels and volume formats                  | 36        |
|           | • RAID levels                                   | 36        |
|           | • Volume formats                                | 37        |
|           | Create volumes                                  | 37        |
|           | Reformat volumes                                | 38        |
|           | Consolidate volumes                             | 38        |
|           | Edit RAID                                       | 39        |
|           | Crypto-erase devices                            | 39        |
|           | Disable/enable security                         | 40        |
|           | View LED states                                 | 40        |
| <br>      |   |           |
| <b>11</b> | <b>Manage Ports</b>                             | <b>41</b> |
| <br>      |   |           |
| <b>12</b> | <b>Manage Network Shares</b>                    | <b>42</b> |
|           | Configure SMB shares                            | 42        |
|           | Configure NFS shares                            | 42        |
|           | • Edit NFS shares                               | 43        |
|           | • Delete NFS shares                             | 43        |
| <br>      |   |           |
| <b>13</b> | <b>Manage Settings</b>                          | <b>44</b> |
|           | Lyve Token Security                             | 44        |
|           | • Import Lyve Token files                       | 44        |
|           | • Delete device authorizations                  | 44        |
|           | • Import a token from a connected USB device    | 44        |
|           | Power   | 44        |
|           | • Restart                                       | 45        |

|  |           |
|--|-----------|
| • Power off .....  | 45        |
| Update Manually .....  | 45        |
| Reset Device .....   | 45        |
| Diagnostics Logs .....   | 45        |
| Discover Lyve Mobile Link .....  | 46        |
| <br>   |           |
| <b>14 .Volume Formats and Network Shares .....</b>                     | <b>47</b> |
| <br>   |           |
| <b>15 .Appliance Management and IP Addressing .....</b>                | <b>49</b> |
| Fixed IP addressing .....  | 49        |
| Cannot access the Link web app.....                                    | 49        |
| <br>   |           |
| <b>16 .Authorize Lyve Mobile Arrays Connected to Other Hosts .....</b> | <b>51</b> |
| Lyve Token file delivery .....   | 51        |
| <br>   |           |
| <b>17 .Regulatory Compliance .....</b>                                 | <b>52</b> |
| FCC DECLARATION OF CONFORMANCE .....                                   | 52        |
| CLASS A .....  | 52        |

# Welcome to Lyve Mobile Link

Lyve<sup>®</sup> Mobile Link lets you share and manage connected Lyve Mobile Arrays on a local network.

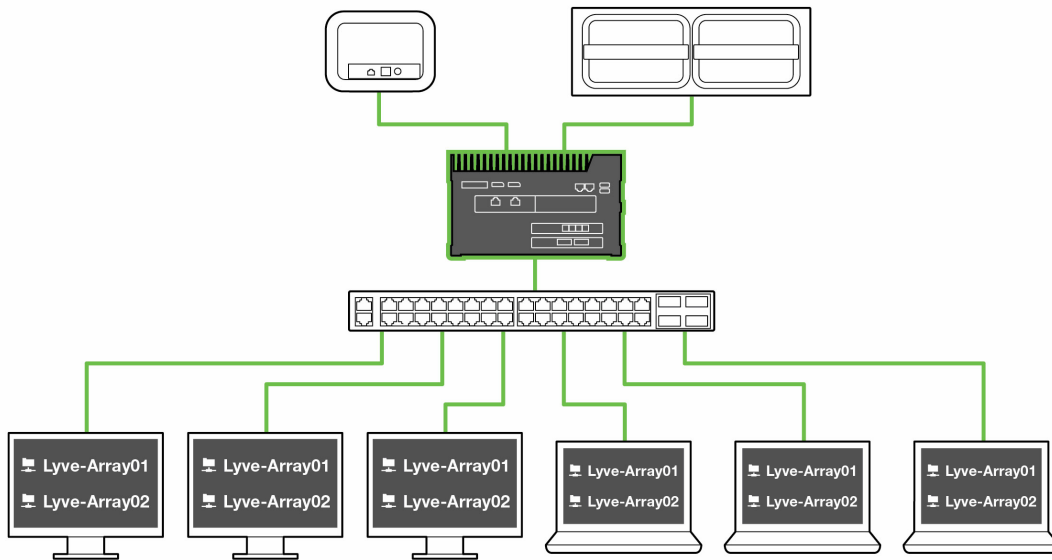

## Parts list

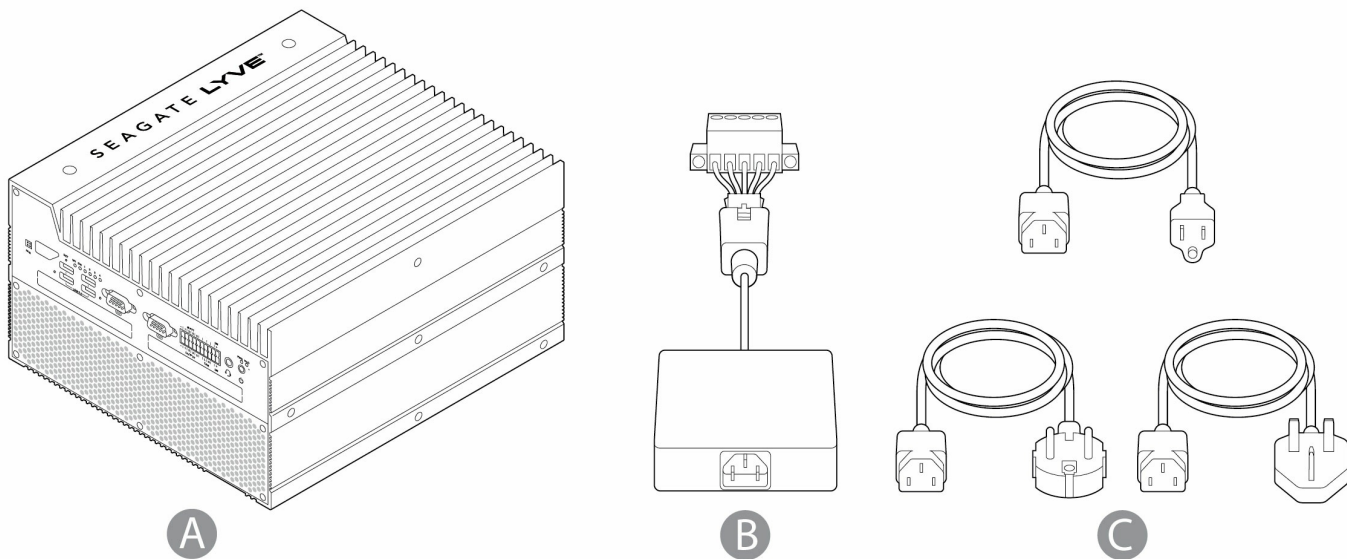

|          |                             |
|----------|-----------------------------|
| <b>A</b> | Lyve Mobile Link            |
| <b>B</b> | Power adapter (24V, 13.75A) |
| <b>C</b> | Adapter plugs (US, EU, UK)  |

# Views

## Front

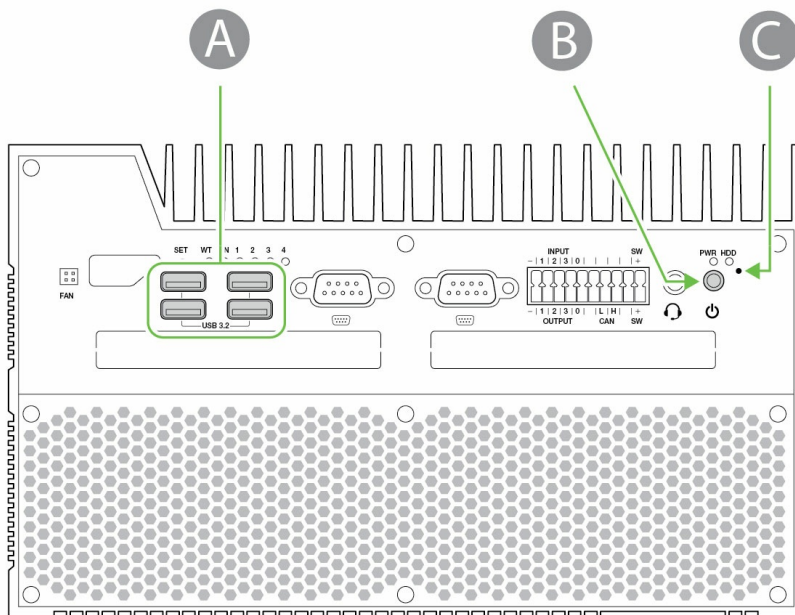

|   |                           |
|---|---------------------------|
| A | 4x USB 3.2 Gen 2 (Type A) |
| B | Power button              |
| C | Reset button (recessed)   |

## Rear

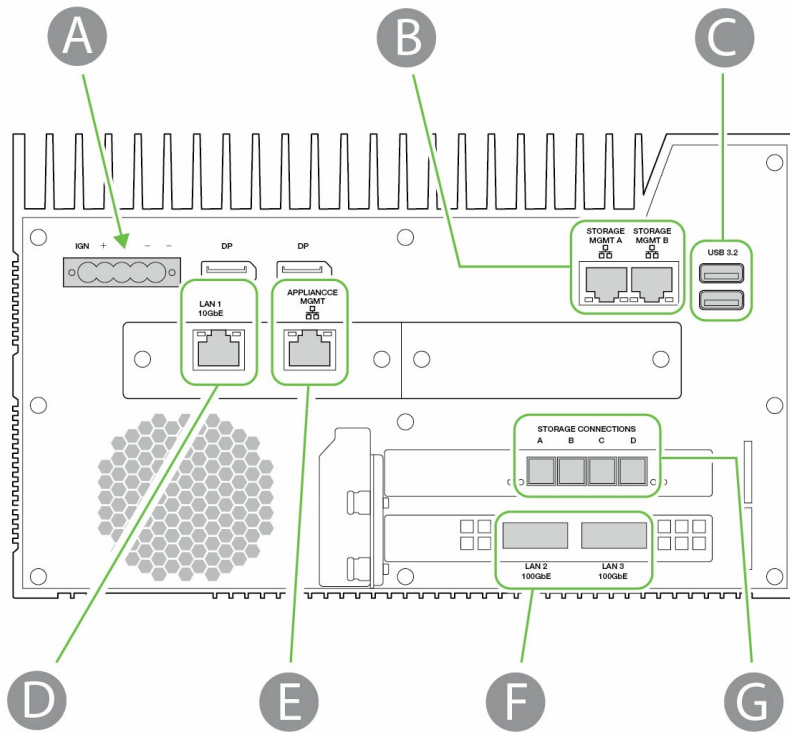

|          |                                |
|----------|--------------------------------|
| <b>A</b> | 1x power input (5 pin)         |
| <b>B</b> | 2x storage management (RJ45)   |
| <b>C</b> | 2x USB 3.2 Gen 2 (Type A)      |
| <b>D</b> | 1x 10GbE LAN (RJ45)            |
| <b>E</b> | 1x Appliance Management (RJ45) |
| <b>F</b> | 2x 100GbE LAN (QSFP56)         |
| <b>G</b> | 4x storage data (SFF-8644)     |



Unidentified ports are disabled.

## Product dimensions

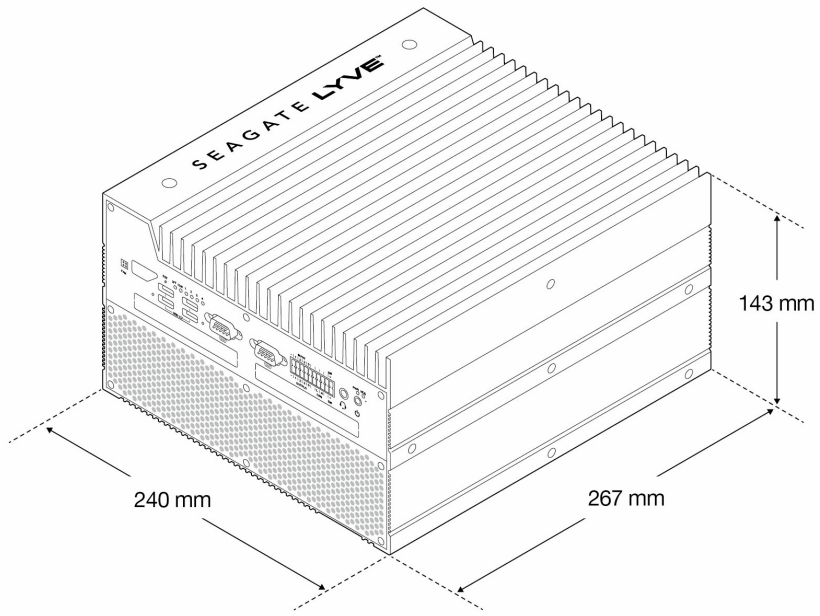



# Specifications

## Network specifications

| Specification     | Supported  |
|-------------------|--|
| Internet protocol | IPv4 (DHCP client and static)  |
| Fallback          | APIPA fallback for DHCP client   |
| Settings          | <ul style="list-style-type: none"><li>• Domain Name System (DNS)</li><li>• Maximum Transmission Unit (MTU)</li></ul> |
| Discovery         | Windows <ul style="list-style-type: none"><li>• SSDP (Link web app)</li><li>• WSD (SMB)</li></ul>                    |
|                   | Mac <ul style="list-style-type: none"><li>• Bonjour (SMB)</li></ul>  |
|                   | Linux <ul style="list-style-type: none"><li>• None</li></ul>   |
| Network services  | <ul style="list-style-type: none"><li>• SMB v2/v3</li><li>• NFS v3 (TCP &amp; UDP) / NFS v4 (TCP)</li></ul>          |

## Lyve Mobile Arrays connected to Lyve Mobile Link

| Specification | Supported  |
|---------------|--|
| Devices       | <ul style="list-style-type: none"><li>• Up to 2 Lyve Mobile Arrays directly connected to Link</li><li>• Supported data connections are PCIe via Lyve PCIe Adapter and SAS via Lyve Mobile Rackmount Receiver</li></ul> |
| Security      | Authorized and unlocked via Lyve Token file  |

| Specification                  | Supported  |  |
|--------------------------------|--|--|
| Network volume mapping         | Automatic  |  |
| Operations                     | Format, edit RAID, crypto-erase, disable/enable security               |  |
| Network share                  | <ul style="list-style-type: none"> <li>• SMB</li> <li>• NFS</li> </ul> |  |
| Lyve Mobile Array file systems | SMB sharing  | <ul style="list-style-type: none"> <li>• ext4</li> <li>• XFS</li> <li>• NTFS</li> <li>• HFS+</li> <li>• exFAT</li> </ul> |
|                                | NFS sharing  | <ul style="list-style-type: none"> <li>• ext4</li> <li>• XFS</li> </ul>  |
|                                | Link web app can format Lyve Mobile Arrays in                          | <ul style="list-style-type: none"> <li>• ext4</li> <li>• XFS</li> <li>• exFAT</li> </ul>                                 |

## Lyve Mobile Arrays connected to other hosts

| Specification  | Supported                                   |
|----------------|---|
| Security       | Authorized and unlocked via Lyve Token file |
| Volume mapping | Automatic                                   |

## Link web app

| Specification | Supported |
|---------------|-----------|
| Protocol      | HTTPS     |



# Connection Types

Lyve Mobile Link requires the following connection types:

- **PCIe or SAS**—Data path between Link and Lyve Mobile Array
- **Ethernet**—Management path between Link and Lyve Mobile Array
- **LAN 10GbE and/or 100GbE**—Data and management path between Link and the local network

Link does not support Fibre Channel, iSCSI, Thunderbolt, and USB connections to Lyve Mobile Array.

## Data connection to Link

Data to/from Lyve Mobile Array passes through PCIe or SAS connections.

| Path | PCIe Adapter/Rackmount Receiver | Link                    | Connector Type |
|------|---------------------------------|-------------------------|----------------|
| Data | PCIe/SAS                        | STORAGE CONNECTIONS A-D | SFF-8644       |

PCIe Adapter

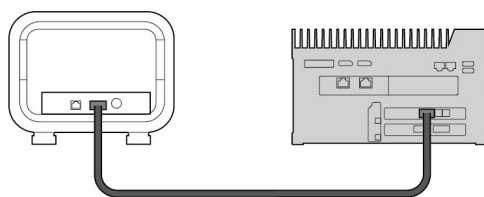

Data

Rackmount Receiver

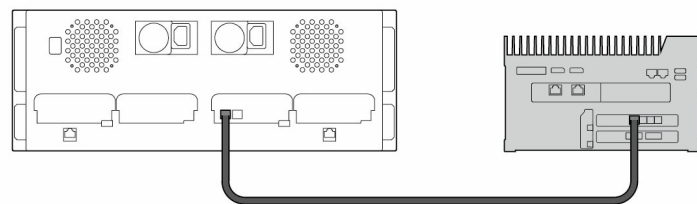

Data



**Note**—Confirm with your project administrator if your Lyve Mobile Arrays and Lyve Mobile Link use PCIe or SAS data paths before following the instructions included in this manual.

## Management connection to Link

Link controls Lyve Mobile Array via a direct Ethernet connection. Ethernet cables are not included with Link.

**i** **Note**—Only direct management connections are supported. Do not use an Ethernet switch when connecting the Ethernet management cables between Lyve Mobile Link and PCIe Adapther / Rackmount Receiver.

| Path       | PCIe Adapter/Rackmount Receiver | Link                | Connector Type |
|------------|---------------------------------|---------------------|----------------|
| Management | Ethernet management             | STORAGE MGMT A or B | RJ45           |

PCIe Adapter

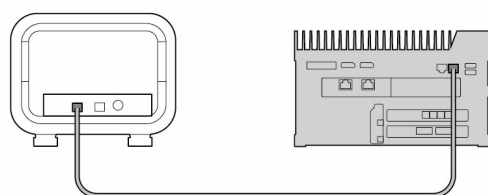

Management

Rackmount Receiver

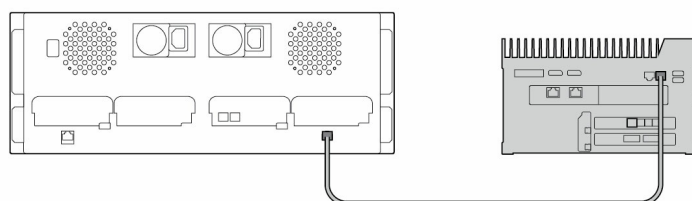

Management

## Data/management connections to network

Link's LAN ports send and receive both data and management information to the local network.

| Path            | Lyve Mobile Link | Network Switch | Connector Type                    |
|-----------------|------------------|----------------|-----------------------------------|
| Data/Management | LAN 1 10GbE      | RJ45           | RJ45 supporting 10GbE performance |
|                 | LAN 2 100GbE     | QSFP56         | QSFP56                            |
|                 | LAN 3 100GbE     | QSFP56         | QSFP56                            |

**i** **Note**—All LAN ports can be connected at the same time. However, Link does not support port aggregation.

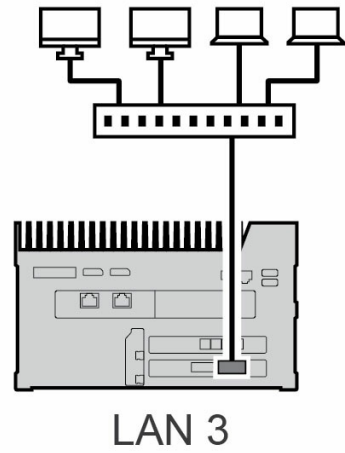
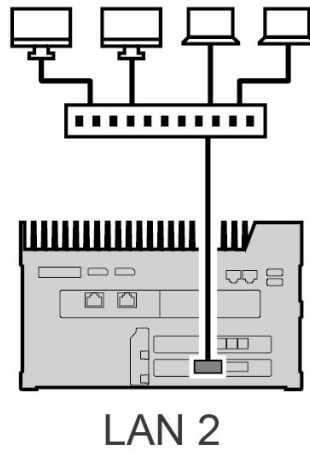
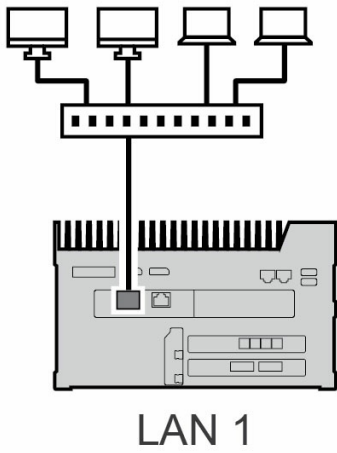

## Appliance management connection

You can connect a PC directly to Link's Appliance Management port for management purposes only. Potential reasons for connecting to the Appliance Management port:

- Your network uses fixed IP addresses.
- You are unable to access the Link web app on the local network.

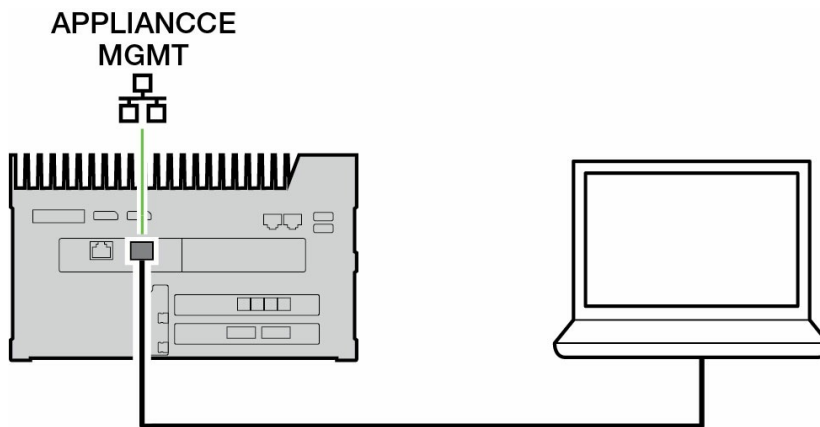

See [Appliance Management and IP Addressing](#).

# Overview of Lyve Mobile Link Setup

Lyve Mobile Link lets hosts on your local network access Lyve Mobile Array storage. The storage is available to hosts as network shares.

Combining flexible operation and rugged mobility, Lyve Mobile Array offers a variety of ways to transport and manage data. Review the following overview of the steps for incorporating Link into your Lyve Mobile system.

1. Install the hardware supporting Lyve Mobile Array usage in your network environment. Note that setup instructions differ between PCIe Adapter and Rackmount Receiver. See [Devices and Services Documentation](#) for links to online manuals.
2. Contact your project administrator to receive the Lyve Token file(s) to authorize access to Link and connected Lyve Mobile Arrays. See [Lyve Token Files](#) for configuration details.
3. Make the connections between Lyve devices and your network:
  - A. Lyve Mobile Array(s) to Link
  - B. Link to your network

See [Connect Devices](#).
4. Access the Link web app via a computer on the same network. Use the web app to sign in to Link. See [Link Web App](#).

## Lyve Mobile Array volume formatting

As part of device configuration, you will need to ensure that the formatting of your Lyve Mobile Array volumes is supported by your network protocol and compatible with your intended data workflow. See [Volume Formats and Network Shares](#)

# Pre-Setup: Lyve Hardware and Software

Documentation for Lyve Mobile devices and services used with Lyve Mobile Link is available online. You can access manuals at the links below for details on how to procure and manage Lyve Mobile storage devices.

| Online Manual                      | Information  | URLs   |
|------------------------------------|--|--|
| Lyve Management Portal             | Account, billing, project, and subscription management | <a href="http://www.seagate.com/manuals/lyve-management-portal/">www.seagate.com/manuals/lyve-management-portal/</a>   |
| Lyve Mobile Array                  | Lyve Mobile Array usage                                | <a href="http://www.seagate.com/lyve-mobile-array">www.seagate.com/lyve-mobile-array</a>   |
| Lyve Mobile Mount and PCIe Adapter | Mobile Mount and PCIe Adapter installation             | <a href="http://www.seagate.com/pcie-adapter-front-loader">www.seagate.com/pcie-adapter-front-loader</a><br><a href="http://www.seagate.com/pcie-adapter">www.seagate.com/pcie-adapter</a> |
| Lyve Mobile Rackmount Receiver     | Rack assembly  | <a href="http://www.seagate.com/rackmount-receiver">www.seagate.com/rackmount-receiver</a>   |
| Lyve Mobile Security               | Lyve Token files and security management               | <a href="http://www.seagate.com/lyve-security">www.seagate.com/lyve-security</a>   |

## Lyve software / hardware solutions

How you authorize and manage Lyve Mobile Array depends upon your use case and the hardware associated with your project.

Lyve Mobile Link has a dedicated web app for sharing Lyve Mobile Arrays on the network. Use a computer on the same network as Link to run the web app in your preferred browser.

Lyve Client and Lyve Mobile Array CLI are used for Lyve Mobile Arrays directly connected to a macOS, Windows, or Linux host. These apps have dedicated installers specific to the host. You cannot use either app to access shares on the network provided by Link.

If you are moving Lyve Mobile Arrays between Link and other hosts, you may need more than one app. For example, the Link web app for the Link connection and Lyve Client on a Windows or Mac host.

The table below provides a simple summary of Lyve software and hardware solutions based upon general use cases.



| Lyve Mobile Array Connection               | Lyve Security: Software or Hardware  | Supported Lyve Mobile Array Data Ports  | Notes  |
|--|--|---|--|
| Single host computer with Lyve software    | Software: <ul style="list-style-type: none"> <li>• Lyve Client app for macOS and Windows</li> <li>• Lyve Mobile Array CLI for Linux and Windows</li> </ul> | <ul style="list-style-type: none"> <li>• Thunderbolt</li> <li>• USB</li> <li>• PCIe Adapter + Ethernet</li> <li>• Fibre Channel via Lyve Mobile Rackmount Receiver</li> <li>• SAS via Lyve Mobile Rackmount Receiver</li> <li>• iSCSI via Lyve Mobile Rackmount Receiver</li> </ul> | <ul style="list-style-type: none"> <li>• A host can be a Linux PC, a Mac, or a Windows PC</li> <li>• Host allowed to install software</li> </ul>   |
| Single host computer without Lyve software | Hardware: <ul style="list-style-type: none"> <li>• Lyve Mobile Padlock</li> </ul>  | <ul style="list-style-type: none"> <li>• PCIe Adapter + Ethernet</li> <li>• Fibre Channel via Lyve Mobile Rackmount Receiver + Ethernet</li> <li>• SAS via Lyve Mobile Rackmount Receiver + Ethernet</li> </ul>   | <ul style="list-style-type: none"> <li>• A host can be a Linux PC or a Windows PC</li> <li>• Host not allowed to install software</li> <li>• Lyve Mobile Padlock unlocks Lyve Mobile Arrays via a local network</li> <li>• Configuring Lyve Mobile Array (RAID, Crypto-Erase, Format) requires a connection to a host with a Lyve app</li> </ul> |

| Lyve Mobile Array Connection   | Lyve Security: Software or Hardware   | Supported Lyve Mobile Array Data Ports   | Notes  |
|--|---|--|--|
| <ul style="list-style-type: none"> <li>• Network sharing (up to two Lyve Mobile Arrays)</li> <li>• No software required on host computers</li> </ul> | <p>Hardware:</p> <ul style="list-style-type: none"> <li>• Lyve Mobile Link</li> </ul> | <ul style="list-style-type: none"> <li>• PCIe Adapter + Ethernet</li> <li>• SAS via Lyve Mobile Rackmount Receiver + Ethernet</li> </ul> | <ul style="list-style-type: none"> <li>• Lyve Mobile Link creates network shares from connected Lyve Mobile Array storage</li> <li>• PC/Mac hosts are connected to the same local network as Link via Ethernet to access shares</li> <li>• Management for Link and connected Lyve Mobile Arrays is performed by Link web app. Run Link web app from a browser on a PC connected to the same network as Link</li> </ul> |

# Lyve Token Files

Lyve Token files provide authorization to access Lyve Mobile software and devices. You must have a Lyve Token file to authorize:

- Signing in to the Link web app
- Lyve Mobile Arrays connected to Lyve Mobile Link

A Lyve Token file is created in Lyve Management Portal by the project administrator and provided to the person who manages Link. It must include the specific Lyve Mobile Link and Lyve Mobile Arrays applicable to the project.

## Sign in to the Link web app

The web app lets you manage Link and connected Lyve Mobile Arrays.

When you open the Link web app, you are prompted to select a token file. You must navigate to the Lyve Token file provided by your project administrator.

For security reasons, you are required to select the Lyve Token file each time you sign in.

## Authorize Lyve Mobile Arrays connected to Link

Token files must be used to authorize Lyve Mobile Arrays connected to Link. There are four ways to deliver a token file authorizing Lyve Mobile Arrays:

- **Include Lyve Mobile Arrays on Link's token file**—The project administrator includes Lyve Mobile Arrays on the same token file used to sign in to the Link web app.
- **Select a token file**—After signing in to the Link web app, you can select a token file to authorize a Lyve Mobile Array. The token file must be selected each time Link and/or the Lyve Mobile Arrays are power cycled.
- **Import a token file**—Use the import option on the Link web app's Settings page. The imported token file automatically authorizes Lyve Mobile Arrays and publishes their shares to the network. The token file must be specifically created with the option to import.
- **Connect USB storage containing a token file**—Copy a token file to the root of a USB storage device and connect it to one of Link's USB ports. Link automatically finds the token file, unlocks Lyve Mobile Arrays, and publishes their shares to the network.

See [Authorize Lyve Mobile Arrays Connected to Other Hosts](#) for more details.

## USB drive as physical key

To avoid selecting or importing token files in the Link web app, you have the option to keep them on the root level of a USB storage device. Connect the USB drive with one or more Lyve Token files to one of Link's USB Type A ports and Link automatically authorizes the connected Lyve Mobile Arrays. Shares from authorized Lyve Mobile Arrays are automatically published to the network.

A USB storage device can provide an additional level of security for an administrator who wants a physical "key" for data access. Lyve Mobile Arrays are immediately unauthorized when the USB storage device with the token(s) is removed.



**Note**—Link's USB ports only support Lyve Token file access.

## Token file delivery

Lyve Token files authorize access to Lyve Mobile Arrays connected to Link. A single token file can authorize multiple Lyve Mobile Arrays or single units.

See the table below for the different ways token files can provide authorization.

| Token Delivery                        | Lyve Mobile Arrays  | Duration   |
|---------------------------------------|---|--|
| Link web app sign-in                  | <ul style="list-style-type: none"> <li>Lyve Mobile Arrays on the same token file as Link are authorized but not mounted on the network.</li> <li>Choose <b>UNLOCK</b> or <b>MOUNT</b> in the Link web UI for an authorized Lyve Mobile Array to publish its share(s) to the network.</li> </ul> | <ul style="list-style-type: none"> <li>Authorization to access the web UI is available for the time that the web browser tab is open.</li> <li>The token file is required with each sign in.</li> <li>Authorization for Lyve Mobile Arrays remains in place as long as Link and the Mobile Arrays are powered on.</li> </ul> |
| Select token file in the Link web app | <ul style="list-style-type: none"> <li>Choose <b>AUTHORIZE</b> to select a token for Lyve Mobile Arrays that appear as <b>Unauthorized</b>.</li> <li>After the Lyve Mobile Array is authorized, choose <b>UNLOCK</b> or <b>MOUNT</b> to publish its share(s) to the network.</li> </ul>         | <ul style="list-style-type: none"> <li>Authorization for Lyve Mobile Arrays remains in place as long as Link and the Lyve Mobile Arrays are powered on.</li> </ul>   |

| Token Delivery                                       | Lyve Mobile Arrays  | Duration  |
|--|---|---|
| <p>Import token file to the Link web app</p>         | <ul style="list-style-type: none"> <li>• Import the token file from the settings page in the Link web app.</li> <li>• Lyve Mobile Arrays on the token file are authorized, unlocked, and mounted on the network.</li> </ul>   | <ul style="list-style-type: none"> <li>• An imported token file allows for continued access to the connected Lyve Mobile Arrays.</li> <li>• No need to reselect the token file with each power cycle of devices.</li> </ul> |
| <p>Connect USB storage containing the token file</p> | <ul style="list-style-type: none"> <li>• Copy the token file to the root of a USB storage device and connect it to one of Link's USB Type A ports.</li> <li>• Link automatically finds the token file.</li> <li>• Lyve Mobile Arrays are authorized, unlocked, and mounted on the network.</li> </ul> | <ul style="list-style-type: none"> <li>• Lyve Mobile Arrays lose their authorization and access when the USB storage device is disconnected.</li> </ul>   |

# Connect Devices

**i** **Note**—Confirm with your project administrator if your Lyve Mobile Arrays and Lyve Mobile Link use PCIe or SAS data paths before following the instructions included in this manual.

## Step 1 – Data path

### PCIe Adapter

- A. Connect a dual SFF-8644 cable to the data port on PCIe Adapter.
- B. Connect the other end of the cable to STORAGE CONNECTION A-B or C-D on Link.

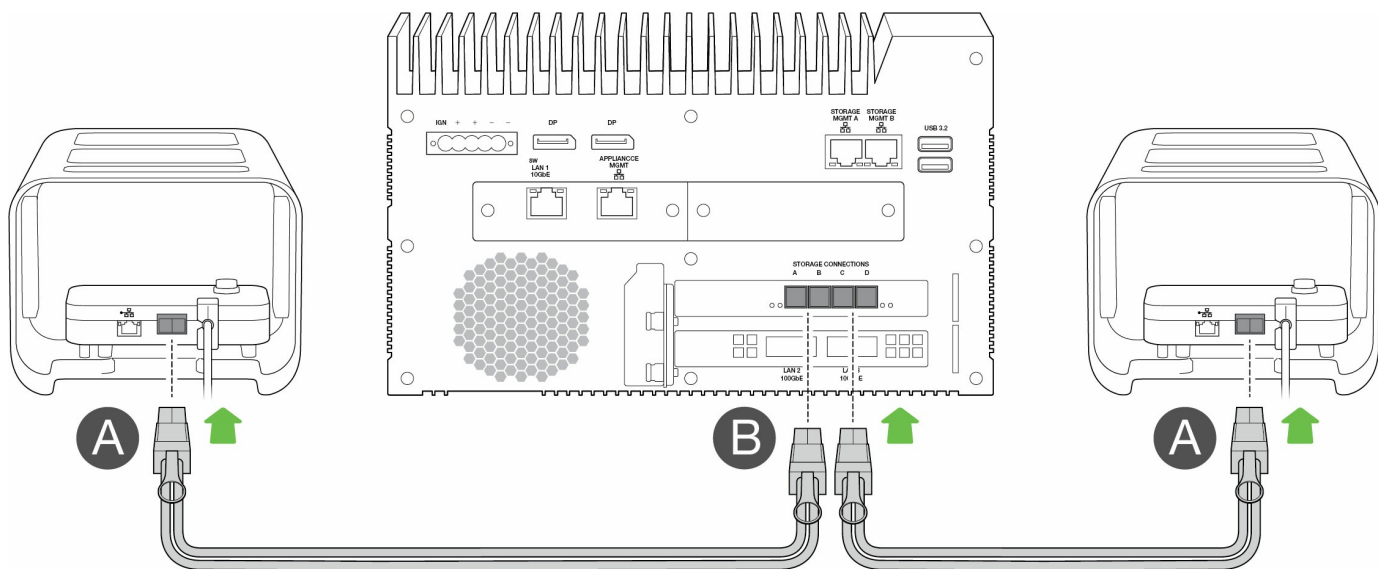

### Rackmount Receiver

- A. Connect a single SFF-8644 cable to a SAS port on Rackmount Receiver.
- B. Connect the other end of the cable to STORAGE CONNECTION A or B on Link.

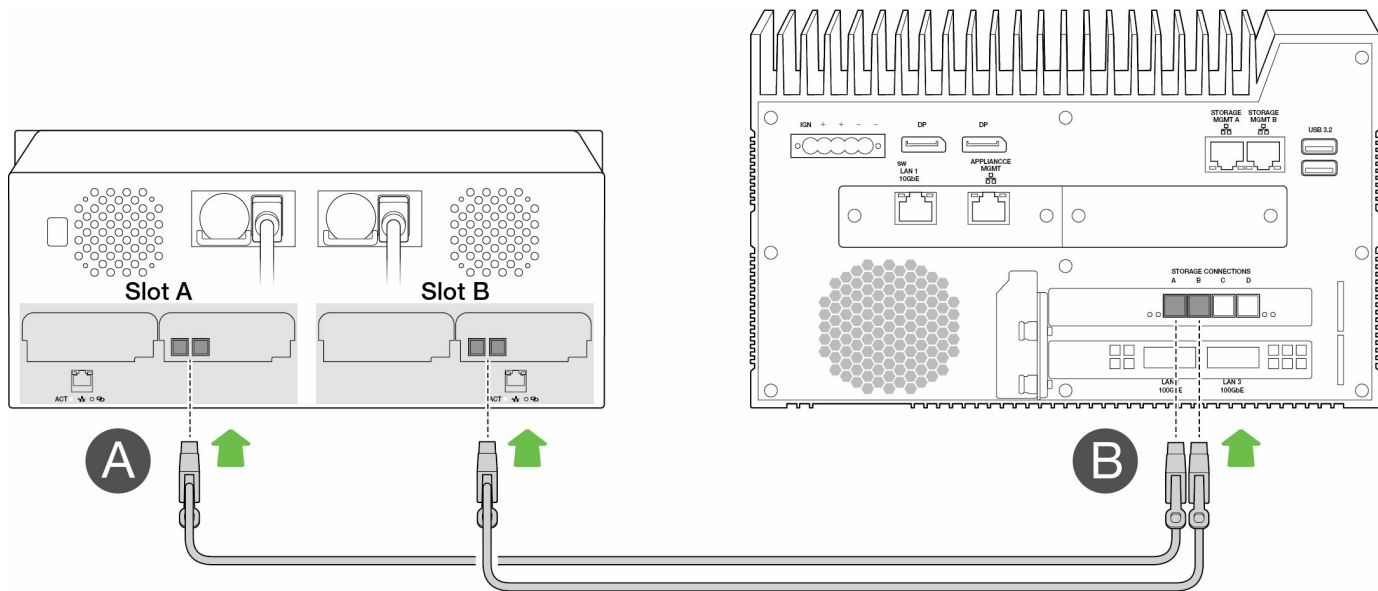

## Step 2 – Management path

**i Important**—Only use a direct Ethernet connection for Storage Management. Do not place an Ethernet switch between Link’s Storage Management ports and the Ethernet ports on PCIe Adapter / Rackmount Receiver.

### PCIe Adapter

- Connect an Ethernet cable to the management port on PCIe Adapter.
- Connect the other end of the cable to STORAGE MGMT A or B on Link. Make sure to select the STORAGE MGMT port controlling data to the STORAGE CONNECTION port selected in step 1.

| Management port | Data ports             |
|-----------------|------------------------|
| STORAGE MGMT A  | STORAGE CONNECTION A-B |
| STORAGE MGMT B  | STORAGE CONNECTION C-D |

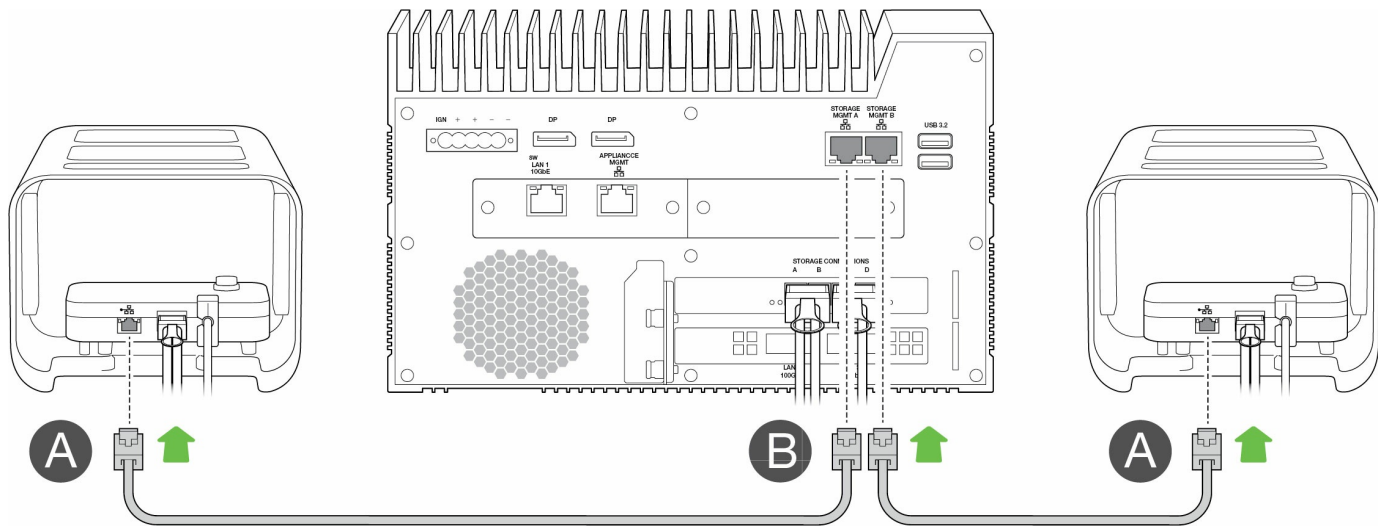

## Rackmount Receiver

- A. Connect an Ethernet cable to a management port on Rackmount Receiver.
- B. Connect the other end of the cable to STORAGE MGMT A or B on Link. Make sure to select the STORAGE MGMT port controlling data to the STORAGE CONNECTION port selected in step 1.

| Management port | Data ports           |
|-----------------|----------------------|
| STORAGE MGMT A  | STORAGE CONNECTION A |
| STORAGE MGMT B  | STORAGE CONNECTION B |

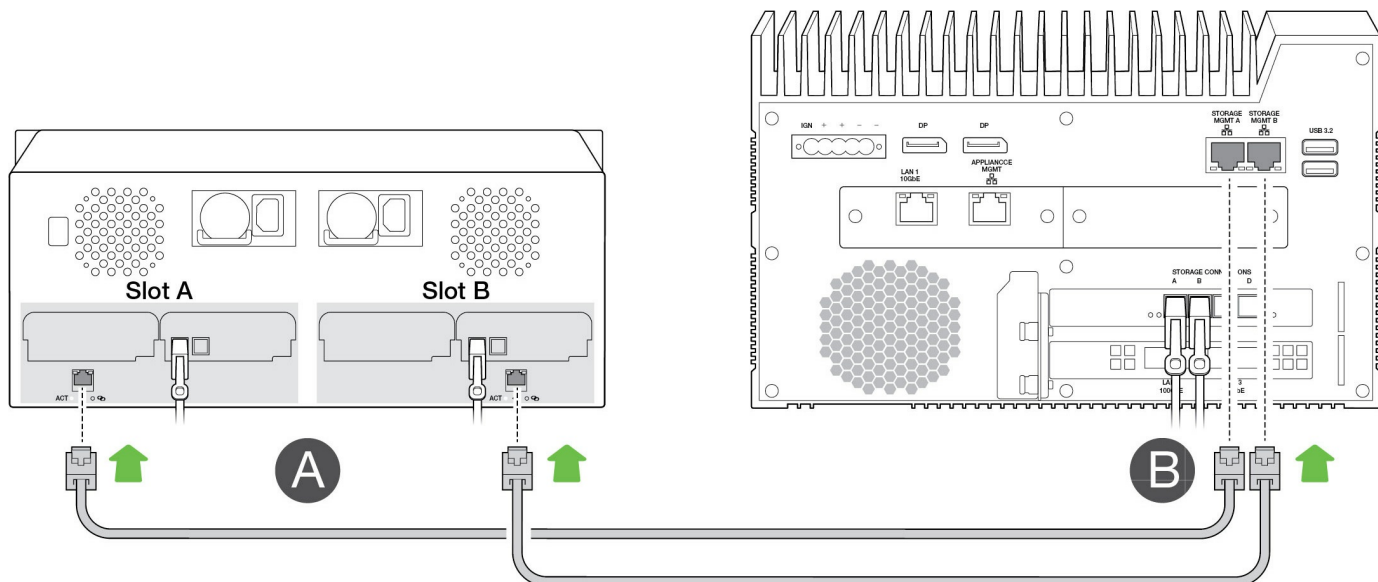

## Step 3 – Local network



**Note**—Network cables are not included with Link.



A. Connect the appropriate cable to one or more of the following LAN ports on Link:

- LAN 1 10GbE (RJ45 supporting 10GbE performance)
- LAN 2 100GbE (QSFP56)
- LAN 3 100GbE (QSFP56)



**Note**—All LAN ports can be connected at the same time. However, Link does not support port aggregation.

B. Connect the other end of the cable to the network switch.

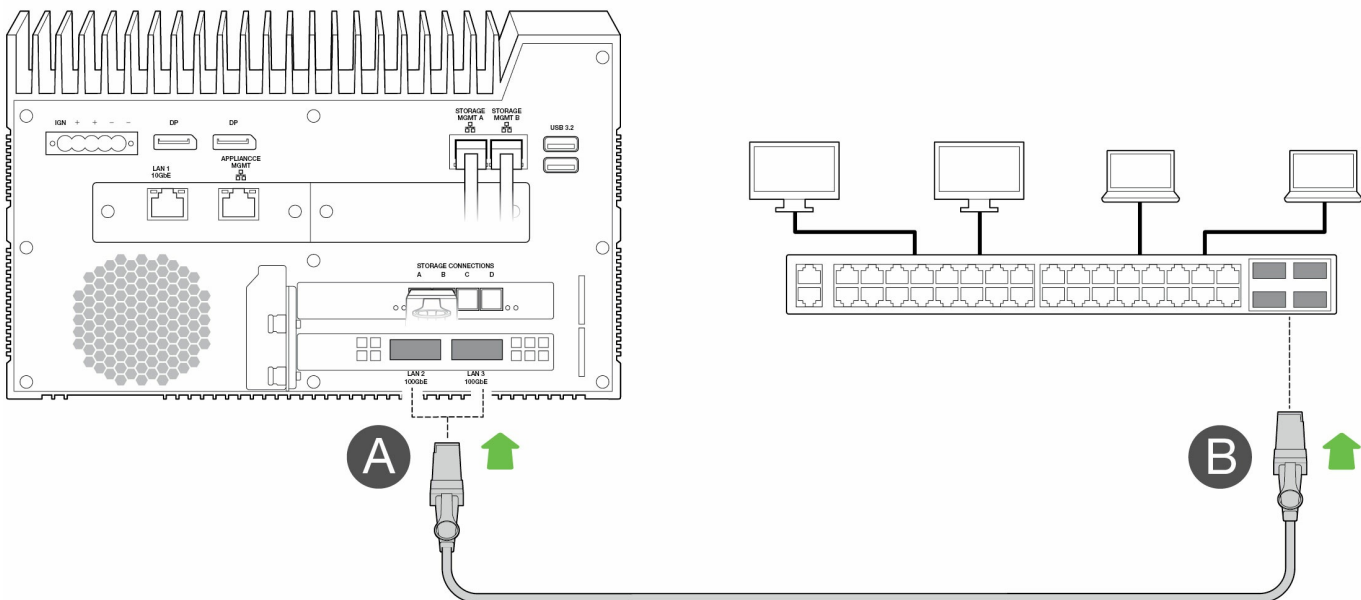
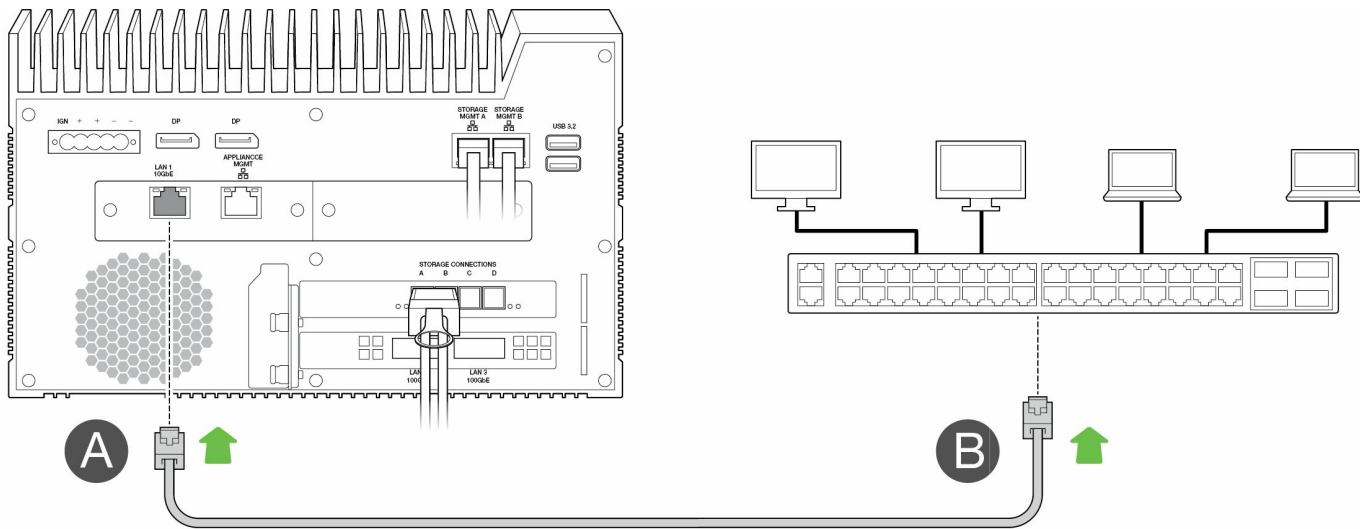

## Step 4 – Power

- A. Connect the power supply to Lyve Mobile Link's power input.
- B. Connect the power cord to the power supply.
- C. Connect the power cord to a live power outlet.

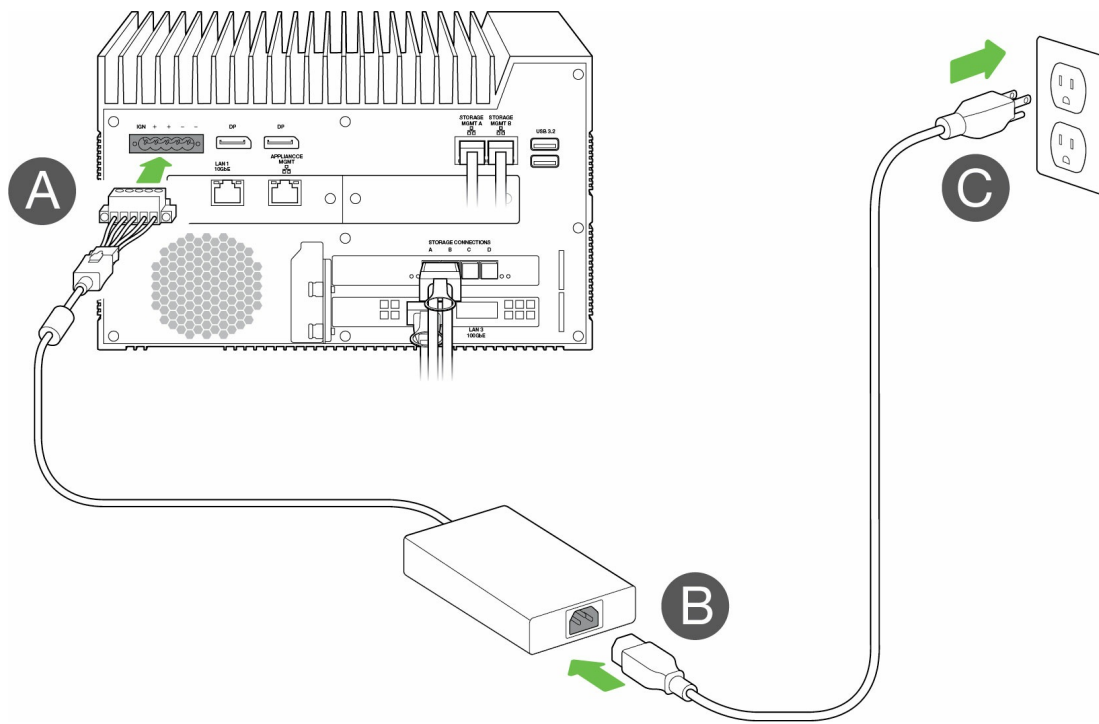

Link will power on once it's connected to a live outlet.

## Step 5 – Power on connected Lyve Mobile Arrays

For more information, see the following user manuals:

| Online Manual                      | URLs   |
|------------------------------------|--|
| Lyve Mobile Mount and PCIe Adapter | <a href="http://www.seagate.com/pcie-adapter-front-loader">www.seagate.com/pcie-adapter-front-loader</a><br><a href="http://www.seagate.com/pcie-adapter">www.seagate.com/pcie-adapter</a> |
| Lyve Mobile Rackmount Receiver     | <a href="http://www.seagate.com/rackmount-receiver">www.seagate.com/rackmount-receiver</a>   |

# Get Started with the Link Web App

The Link web app is a browser-based interface that lets you:

- Authorize Lyve Mobile Link
- Unlock and manage Lyve Mobile Arrays connected to Link
- Configure network shares
- Change volume formats and RAID levels
- Crypto-erase data on Lyve Mobile Arrays
- Unlock Lyve Mobile Arrays connected to other hosts and found on your local network

You can run the Link web app on a single host on the same network as Link. You must sign in to the Link web app for shares to appear on the local network.

## **i** Link web app and other Lyve software

Lyve Mobile Link has its own web app for management and security. Other Lyve software apps such as **Lyve Client** and **Lyve Mobile Array CLI** are used to manage Lyve Mobile Arrays that are connected directly to a host. Lyve Client and Lyve Mobile Array CLI cannot be used to access shares on the network provided by Link.

## Open the Link web app

See the following instructions for your operating system.

### Windows

1. On your Windows PC, open a file browser and click **Network**.
2. Click on the Link icon under **Other Devices**.

The Link web app launches in your default browser.

### Linux and macOS

1. On your Linux or Mac computer, open a web browser.
2. Navigate to `https://Link-SerialNumber.local`, replacing *SerialNumber* with the 8-digit serial number found on the label on the bottom of Lyve Mobile Link.

## Sign in with a Lyve Token file

A Lyve Token file authorizing Link must be provided when signing in to the Link web app. A token file can be downloaded from the Lyve Management Portal or provided by your project administrator. See [Lyve Token Files](#).

1. Open the Link web app. At the prompt, click **SELECT TOKEN FILE**
2. Navigate to the location of the token file authorizing access to Link.
3. Select the token file and click **Open**.



**Note**—For security reasons, it is not possible to sign in to the Link web app on more than one host at a time. Signing in to the Link web app on a second host will automatically disconnect the first sign in.

# View Device Info

Click on the **About** tab in the navigation bar to view information on Lyve Mobile Link.

## Device info

View the following device details:

| Info          | Notes                                    |
|---------------|--|
| Hostname      | Network ID                               |
| Model         | Lyve Mobile Link                         |
| Model Number  | Link model number                        |
| Serial Number | Serial number for this Link device       |
| FW Version    | Last installed firmware version          |
| Date          | Current date and time                    |
| Default MAC   | Default MAC address for this Link device |

## Ethernet port info

View the following details related to Link's Ethernet and Appliance Management ports:

| Info        | Notes                                      |
|-------------|--|
| Mac Address | MAC address for this network interface     |
| Link        | Connection status and speed (if available) |
| IPv4        | IP address (IPv4)                          |
| Netmask     | Subnet mask                                |
| Gateway     | Gateway IP address                         |



Ethernet port IP addresses can be edited on Link web app's Ports page. See [Manage Ports](#).

# Manage Devices

Use the Link web app to view both direct-connected and network devices. Click on the **Devices** tab in the navigation bar to view:

- **Connected Devices**—Lyve Mobile Arrays connected directly to Lyve Mobile Link.
- **Other Devices**—Lyve Mobile Arrays detected on the local network. If your network environment includes other PCs connected to Lyve Mobile Arrays via PCIe Adapter, Fibre Channel, or SAS, you can use Lyve Mobile Link to unlock them. Link cannot publish shares from Lyve Mobile Arrays connected to other hosts.
- **Disconnected Devices**—Other Lyve Mobile Arrays that were added manually to the Link web app but are currently disconnected.

## View Lyve Mobile Arrays

View the following details on each device card:

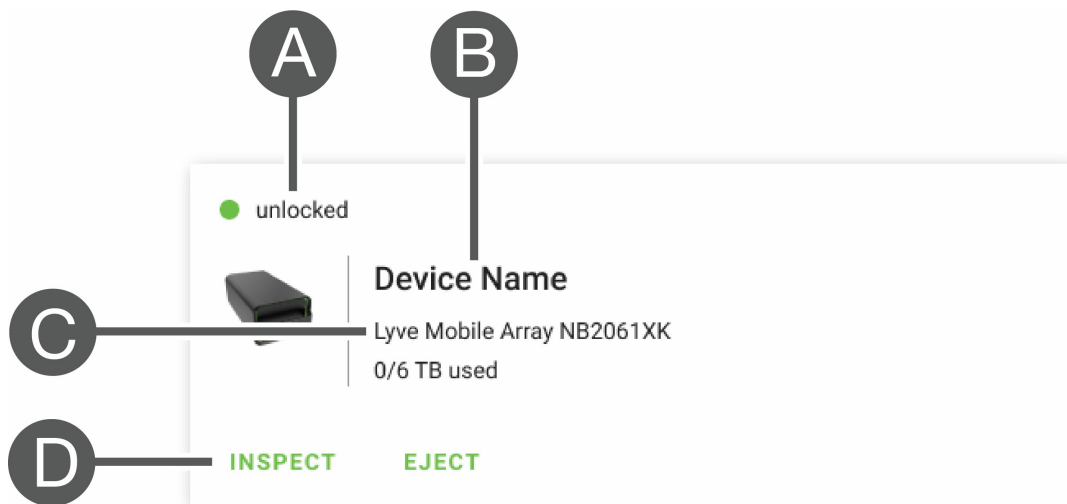

|   |                            |
|---|----------------------------|
| A | State / action in progress |
| B | Name                       |
| C | Type / Serial Number       |
| D | Actions                    |

## Lyve Mobile Array States







| Reported Status |              | Authorized by Lyve Token file | Unlocked | Volumes mounted | Next steps   |
|-----------------|--------------|-------------------------------|----------|-----------------|--|
| ●               | disconnected | N/A                           | N/A      | N/A             | Previously added device is currently disconnected. Check device connections and make sure it's powered on. You can use the Link web app to forget a disconnected device if you don't want it listed in Link web app. |
| ●               | locked       | ✓                             | X        | X               | Device is authorized but currently locked. In Link web app, go to the Devices page and click <b>UNLOCK</b> .   |
| ●               | not mounted  | ✓                             | ✓        | X               | Device is authorized and currently unlocked, but volumes are not mounted/shared on network. In Link web app, go to the Devices page and click <b>MOUNT</b> .   |
| ●               | not secured  | ✓                             | X        | X               | Device is authorized but it may be in an unsecured state. Link allows users to disable security if needed.   |
| ●               | unlocked     | ✓                             | ✓        | ✓               | Device is ready for use.   |



|   |                                  |     |     |     |   |
|---|----------------------------------|-----|-----|-----|---|
| ● | unauthorized                     | X   | X   | X   | Device is not authorized by a Lyve Token file. See <a href="#">Lyve Token Files</a> and See <a href="#">Authorize Lyve Mobile Arrays Connected to Other Hosts</a> for the different ways a device can be authorized.  |
| ● | unsupported volume configuration | N/A | N/A | N/A | Lyve Mobile Array has been configured with one of the following: <ul style="list-style-type: none"> <li>• An unsupported file system format (for example, APFS). Reformat the drive in a supported format.</li> <li>• Multiple volumes or partitions. Use the Link web app to consolidate volumes.</li> </ul> |

## Actions in progress

| Reported Status |                 | Notes   |
|-----------------|-----------------|---|
| ●               | authorizing     | Link is authorizing Lyve Mobile Array.            |
| ●               | connecting      | Link is getting information on Lyve Mobile Array. |
| ●               | creating volume | Link is creating the volume on Lyve Mobile Array. |
| ●               | crypto-erasing  | Link is crypto-erasing Lyve Mobile Array.         |

|   |                   |   |
|---|-------------------|---|
|  | deleting volume   | Link is deleting the volume on Lyve Mobile Array.   |
|  | ejecting device   | Link is ejecting the device. Always safely eject the device before disconnecting Lyve Mobile Array.   |
|  | formatting volume | Link is formatting the volume on Lyve Mobile Array.   |
|  | mounting volume   | Link is publishing Lyve Mobile Array's volume to the local network.   |
|  | unmounting volume | Link is unmounting Lyve Mobile Array's volume from the local network.   |
|  | unlocking         | Link is attempting to unlock Lyve Mobile Array.   |
|  | action failed     | Link could not perform the requested operation. Confirm that you have followed the onscreen instructions. Contact <a href="#">Lyve Support</a> if you continue to experience issues |

## Authorize devices

1. Go to the Devices page.
2. Click **AUTHORIZE** on the appropriate device card.
3. Click **Token File**.
4. Navigate to the location of the appropriate token file (.ltk). Select the file and click **Open**.
5. Click **AUTHORIZE**.
6. Wait for Link web app to complete the authorization.

## Unlock/mount devices manually to publish shares

A Lyve Mobile Array can be authorized but in an unlocked or unmounted state. In either state, Lyve Mobile Array's volume has yet to be published to the network. Follow the instructions below to publish the volume to the network.

1. Go to the Devices page.
2. Click **UNLOCK** or **MOUNT** on the appropriate device card.

## Eject devices

Lyve Mobile Arrays can be safely ejected using the Link web app. Once ejected, a Lyve Mobile Array can be safely disconnected from Link.

**!** **Important**—Disconnecting a Lyve Mobile Array without first ejecting may lead to data loss. Verify that no transfers are in progress before proceeding to eject the device.

1. Go to the Devices page.
2. Click **EJECT** on the appropriate device card.
3. Confirm the serial number of the device you want to eject, and make certain that no data transfers are in progress.
4. Click **EJECT DEVICE**.

## Add other devices

If your network environment includes other PCs connected to Lyve Mobile Arrays via PCIe Adapter, fibre channel, or SAS, you can use Lyve Mobile Link to unlock them. The Lyve Mobile Arrays are mounted on their specific hosts and not published to the network.

In most cases, Link will automatically detect Lyve Mobile Arrays on the same local network. If you do not see your Lyve Mobile Array in this section of the Link web app, you can add it manually.

1. Go to the Devices page.
2. In the Other Devices section, click **ADD DEVICE**.
3. In the dialog, enter the following:
  - Hostname or IP address (IPv4 or IPv6) of the device you want to add.
  - Device serial number.
4. Click **CONNECT**.
5. Wait while Lyve web app searches for the device.
6. At the prompt, click **CONFIRM**.

## Forget disconnected devices

Manually added devices that are currently offline are displayed in the Disconnected Devices section on the Devices page. If you no longer wish a device to be listed there, you can remove it.

1. Go to the Devices page.
2. Click **FORGET DEVICE** on the appropriate device card.
3. In the warning dialog, click **FORGET DEVICE**.

## Inspect devices

The Inspect view provides additional device information and access to critical device management functions such as editing RAID and formatting, crypto-erasing the device, and consolidating volumes.

1. Go to the Devices page.
2. Click **INSPECT** on the appropriate device card.
3. Review the following information on the inspected device:

| Info               | Notes  |
|--------------------|--|
| Type               | Lyve Mobile Array  |
| Serial #           | Device serial number. Click on the icon to copy the serial number to your clipboard. |
| Model              | Device model number  |
| Management port    | MGMT A or MGMT B   |
| Storage connection | PCIe Adapter or Rackmount Receiver   |

The Inspect page also lets you:

- [Disable/enable security for the device](#)
- [Securely erase the device](#)
- [Create volumes](#)
- [Reformat volumes](#)
- [Consolidate volumes](#)
- [Edit RAID](#)
- [View LED states](#)

## RAID levels and volume formats

### RAID levels

RAID stands for **redundant array of independent disks**. RAID contains the word 'array', and the two terms are often used interchangeably. An array is a combination of physical disks that are presented to the operating system as a single volume.

Disks are combined into different RAID configurations known as RAID levels. The RAID level you choose depends on which storage attributes are most important to you:

|                    |   |
|--------------------|---|
| <b>Capacity</b>    | The total amount of data you can store                |
| <b>Performance</b> | The speed at which data is copied                     |
| <b>Protection</b>  | The number of disks that can fail before data is lost |

Available RAID levels in Link web app are RAID 0 and RAID 5:

**RAID 0**—Data is not duplicated across all drives. This results in faster transfers and more storage, since the full capacity of all drives can be used to store data. However, RAID 0 lacks data protection. If a single drive fails, all data in the array is lost. Volume initialization is not required.

**RAID 5**—Data is written in blocks across all drives, with some storage used to provide redundancy. No loss of data occurs in the event one of the drives in the array fails. RAID 5 read performance approaches RAID 0, but write performance is slower because redundant blocks must also be written. RAID 5 is a good choice when protecting your data is more important than performance or overall storage space.

**i** **Important note**—Volume initialization for RAID 5 may take 32 hours or more. You can use the device during initialization but performance will be degraded.

## Volume formats

Ensure that the formatting of your Lyve Mobile Array volume is supported by your network protocol and compatible with your intended data workflow:

- ext4 and XFS provide optimal performance for Lyve Mobile Arrays when connected to Lyve Mobile Link for sharing on the local network. However, ext4 and XFS are not native formats for Windows and macOS operating systems, making it difficult to move Lyve Mobile Arrays between network sharing via Link and direct connections to other hosts. Use ext4 or XFS if you intend *only* share Lyve Mobile Arrays on the network.
- If your data workflow also requires connecting Lyve Mobile Array directly to Windows and/or macOS computers (as well as to Link), choose exFAT. Note that volumes formatted as exFAT can only use the SMB network service and are not compatible with NFS environments.

**i** If you are moving Lyve Mobile Arrays between Link and other hosts, you have the option to format on the other host. Link is compatible with NTFS for Windows and HFS+ for macOS.

Link supports the SMB network service for a Lyve Mobile Array formatted as NTFS or HFS+.

For more information, see [Volume Formats and Network Shares](#)

## Create volumes

If a volume hasn't been configured on a Lyve Mobile Array, you can use Link web app to create one.

**i** If no volume is detected but you know that one was already created on the device, check all cables to confirm proper connections (power, data, and network). You can also disconnect the data storage cable and then reconnect it.

Creating a volume requires selecting a **RAID level** and **volume format**. Before proceeding, you should consider the RAID level and format best suited to how you move and store data in your network

environment. See [RAID levels and volume formats](#) above.

! Creating a volume will erase all data on the device. Make certain to transfer all data to another storage device before creating the volume.

1. Go to the Devices page.
2. Click **INSPECT** on the appropriate device card.
3. Click **CREATE VOLUME** in the RAID Array section.
4. Select a RAID level for the volume: RAID 0 or RAID 5. Click **NEXT**.
5. Select a volume format: ext4, XFS, or exFAT. Click **NEXT**.
6. Review the configuration summary and click **CONFIRM**.
7. Wait while Link web app sets up the RAID and formats the volume.

## Reformat volumes

Before reformatting a volume, consider which format is best suited to your network environment. See [Volume Formats and Network Shares](#)

Reformatting will erase all data on the device. Make certain to transfer all data to another storage device before proceeding.

1. Go to the Devices page.
2. Click **INSPECT** on the appropriate device card.
3. Click **FORMAT** in the RAID Array section.
4. In the warning dialog, click **FORMAT** to confirm that all data on the device will be erased.
5. Select a volume format: ext4, XFS, or exFAT. Click **NEXT**.
6. Review the configuration summary and click **CONFIRM**.
7. Wait while Link web app formats the volume.

## Consolidate volumes

If a Lyve Mobile Array has been configured elsewhere with multiple volumes or partitions, it will have an **unsupported volume configuration** status in Link web app. You can use the web app to reformat the device with a single volume using all available capacity.

Before consolidating, consider which format is best suited to your network environment. See [Volume Formats and Network Shares](#).

! Consolidating volumes will erase all data on the device. If you have data stored on the device, you should connect it to a different host to transfer files to another storage device.

1. Go to the Devices page.
2. Click **CONSOLIDATE** on the appropriate device card.

3. In the warning dialog, click **CONSOLIDATE** to confirm that all data on the device will be erased.
4. Select a format for the consolidated volume: ext4, XFS, or exFAT.
5. Click **START**.
6. Wait while Link web app reformats the device.

## Edit RAID

You can use Link web app to change a Lyve Mobile Array's RAID level.

Editing the RAID requires selecting a **RAID level** and **volume format**. Before proceeding, you should consider the RAID level and format best suited to how you move and store data in your network environment. See [RAID levels and volume formats](#) above.

**!** **Important**—Configuring the RAID will erase all data on the device. Make certain to transfer all data to another storage device before editing the RAID.

1. Go to the Devices page.
2. Click **INSPECT** on the appropriate device card.
3. Click **EDIT RAID** in the Raid Array section.
4. Select a RAID level for the volume: RAID 0 or RAID 5. Click **NEXT**.
5. Select a volume format: ext4, XFS, or exFAT. Click **NEXT**.
6. Review the configuration summary and click **CONFIRM**.
7. Wait while Link web app sets up the RAID and formats the volume.

## Crypto-erase devices

You can use Link web app to securely erase data on a Lyve Mobile Array. All data is permanently deleted, however, device settings are retained.

A crypto-erase requires selecting a **RAID level** and **volume format** for the erased drives. Before proceeding, you should consider the RAID level and format best suited to how you move and store data in your network environment. See [RAID levels and volume formats](#) above.

**!** Once a crypto-erase is started, data on the device can no longer be recovered. Before initiating the crypto-erase, make certain to transfer all data to another storage device and verify that no transfers are in progress.

1. Go to the Devices page.
2. Click **INSPECT** on the appropriate device card.
3. Click **CRYPTO-ERASE** in the Device Security section.
4. In the warning dialog, acknowledge that all data will be permanently deleted. Click **NEXT**.
5. Select a RAID level for the volume: RAID 0 or RAID 5. Click **NEXT**.
6. Select a volume format: ext4, XFS, or exFAT. Click **NEXT**.

7. In the warning dialog, acknowledge that all data will be permanently deleted. Review the configuration summary for the new volume and click **CRYPTO-ERASE**.
8. Wait while Link web app sets up the RAID and formats the volume.

## Disable/enable security

Disabling security on a Lyve Mobile Array allows it to be moved to another host without the need for Lyve credentials or a Lyve Token file. The host could be Linux, macOS, or Windows.



**Note**—A Lyve Token file is always required when connecting to Lyve Mobile Link.

To disable security:

1. Go to the Devices page.
2. Click **INSPECT** on the appropriate device card.
3. Click **DISABLE SECURITY** in the Device Security section.
4. In the warning dialog, click **DISABLE SECURITY** to acknowledge that security will be removed.
5. Wait while Link web app disables security.

To enable security:

1. Go to the Devices page.
2. Click **INSPECT** on the appropriate device card.
3. Click **ENABLE SECURITY** in the Device Security section.
4. Wait while Link web app enables security.

## View LED states

Use Link web app to review Lyve Mobile Array's LED states/colors/patterns.

1. Go to the Devices page.
2. Click **INSPECT** on the appropriate device card.
3. Click **LED STATES**.
4. After reviewing, click **CLOSE**.



# Manage Ports

Click on the **Ports** tab in the navigation bar to view the following connections:

- **Device**—Link data and management ports connected to Lyve Mobile Arrays. See [Connect Devices](#).
- **LAN / Host**—Link LAN ports connected to the local network. See [Connect Devices](#).
- **Appliance Management**—Link Appliance Management port directly connected to a PC. See [Appliance Management and IP Addressing](#).
- **Other**—USB ports for Lyve Token file detection. See [Authorize Lyve Mobile Arrays Connected to Other Hosts](#).

# Manage Network Shares

Click on the **Network Shares** tab in the navigation bar to:

- Configure SMB shares
- Add/edit/delete NFS shares

## Configure SMB shares

|                 |  |
|-----------------|--|
| <b>Format</b>   | SMB is available with the following file system formats: ext4, XFS, NTFS, HFS+, and exFAT. |
| <b>Security</b> | Network volume credentials can be assigned to SMB shares.                                  |

1. In the SMB Shares section, ensure that the toggle switch is **On**.
2. Click **CONFIGURE**.
3. Choose your network privacy setting: **Public** or **Private**. **Note**—Settings are applied to all SMB shares.
4. (Private network only) Enter a username and password.
5. Click **Apply**.

## Configure NFS shares

|                 |  |
|-----------------|--|
| <b>Format</b>   | NFS is compatible with ext4 and XFS formats only. <b>Note</b> —ext4 and XFS are not native file formats for macOS and Windows. They are recommended for Lyve Mobile Arrays that are only used for network shares. Lyve Mobile Arrays formatted ext4 or XFS should not be directly attached to a host via Thunderbolt or USB. |
| <b>Security</b> | After enabling NFS, you can limit access to a share by host IP address.  |

1. In the NFS Shares section, ensure that the toggle switch is **On**.
2. Click **ADD CONFIGURATION**.
3. Enter a path using the following syntax:

*/media/external/Lyve\_SerialNumber.PartitionNumber*

where *SerialNumber* is the Lyve Mobile Array's serial number and *PartitionNumber* is the number of partitions in the volume. If you don't know the serial number, you can find it by scanning the QR code on the left side of the Lyve Mobile Array handle.



4. Specify allowed hosts. Enter an asterisk (\*) wildcard to allow any host to access this NFS share. If you want to restrict access to only one host, enter a host IP address or hostname.

**i** You can restrict access to the general network even as you give access to more than one host. To provide this type of limited access, create additional NFS shares using the same data path.

5. Select a performance setting: **Synchronous** or **Asynchronous**.

**i** In asynchronous mode, the server does not wait for data to be written to storage before responding to the NFS client. This can save time for requests and improve performance. However, in the event of power loss, data could be lost.

In synchronous mode, the server replies to NFS clients only when the data has been written to stable storage. The potential for data loss is reduced, but at the cost of performance.

6. Select a Permission setting: **Read only** or **Read/Write**.
7. Click **APPLY**.

## Edit NFS shares

1. In the NFS Shares section, click on the Edit icon next to the NFS share you want to edit.
2. Edit settings as needed.
3. Click **APPLY**.

## Delete NFS shares

1. In the NFS Shares section, click on the Trash icon next to the NFS share you want to delete.
2. In the warning dialog, click **REMOVE** to confirm the deletion.

# Manage Settings

Click on the **Settings** tab in the navigation bar to:

- Import Lyve Token files.
- Remove Lyve Mobile Array authorizations.
- Restart or power off Lyve Mobile Link.
- Manually update Link firmware.
- Reset Link settings and remove imported token files.
- Download diagnostic logs.

## Lyve Token Security

### Import Lyve Token files

Lyve Token files can be imported in order to authorize and unlock Lyve Mobile Arrays connected directly to Link. Your project administrator must specify that the token can be saved when creating it in Lyve Management Portal. If this option is not selected, the token cannot be imported.

1. In the Lyve Token Security section, click **IMPORT TOKEN FILE**
2. Navigate to the location of the appropriate token file (.ltk). Select the file and click **Open**.
3. A list of devices authorized by the token file is displayed. Devices that are checked will automatically be unlocked by Link when detected. Uncheck any devices you do not want Link to automatically unlock.
4. Click **IMPORT TOKEN**.
5. Click **DONE**.

### Delete device authorizations

You can delete previously imported device authorizations.

1. In the Lyve Token Security section, click **AUTHORIZED DEVICES**.
2. On the Imported tab, click the Trash icon next to the device authorization you want to remove.
3. Click **CLOSE**.

### Import a token from a connected USB device

You can import a token stored on a USB device.

1. In the Lyve Token Security section, click **AUTHORIZED DEVICES**.
2. On the USB tab, click the Import icon next to the USB device.
3. Click **CLOSE**.

## Power

## Restart

Restarting Lyve Mobile Link will cancel network transfers and device operations in progress.

1. In the Power section, click **RESTART**.
2. In the warning dialog, click **RESTART** to confirm the action.



Do not close the browser tab after clicking **RESTART**. Link will reconnect once the restart is complete.

## Power off

Powering off Lyve Mobile Link will cancel network transfers and device operations in progress.

1. In the Power section, click **POWER OFF**.
2. In the warning dialog, click **POWER OFF** to confirm the action.

## Update Manually

Firmware updates downloaded from Lyve support can be manually uploaded to Link.

1. In the Update Manually section, click **UPLOAD UPDATE**.
2. Navigate to the location of the appropriate firmware update file (.box). Select the file and click **Open**.
3. Click **START UPDATE**.
4. Wait while Link web app completes the firmware update.
5. When the update is complete, click **REFRESH** to reload the browser page.

## Reset Device

A reset reverts settings to their defaults and removes imported Lyve Token files. Your data on connected Lyve devices is safe and will not be affected by a reset.

1. In the Reset Device section, click **RESET**.
2. In the warning dialog, click **RESET** to confirm the action.
3. Wait as Link web app resets the device.
4. When the reset is complete, click **REFRESH** to reload the browser page.

## Diagnostics Logs

To troubleshoot an issue, you may be asked to download diagnostics logs and related system logs.

1. In the Diagnostic Logs section, click **DOWNLOAD LOGS**.
2. Navigate to the location where you would like the logs saved.
3. Click **Save**.

# Discover Lyve Mobile Link

You can view tutorials to Lyve Mobile Link's key features. In the Discover Lyve Mobile Link section, click on any of the links provided.

# Volume Formats and Network Shares

Lyve Mobile Array volumes can be shared on the network using the Server Message Block (SMB) or Network File System (NFS) protocol. Volumes formatted as NTFS, HFS+, or exFAT can only use the SMB network service, while volumes formatted as ext4 and XFS can use both SMB and NFS.

| Format | SMB | NFS |
|--------|-----|-----|
| ext4   | Yes | Yes |
| XFS    | Yes | Yes |
| exFAT  | Yes | No  |
| NTFS   | Yes | No  |
| HFS+   | Yes | No  |

ext4 and XFS provide optimal performance for Lyve Mobile Arrays when connected to Lyve Mobile Link for sharing on the local network. Use either format if you intend to only share Lyve Mobile Arrays on a network.

However, before formatting Lyve Mobile Array volumes using the Link web app, consider which file system formats are best for your data workflow. If your data workflow requires connecting Lyve Mobile Arrays directly to Windows and/or macOS computers as well as to Link, then NTFS, HFS+, or exFAT are more appropriate volume formats. ext4 and XFS are not native formats for Windows and macOS operating systems, making it difficult to move Lyve Mobile Arrays between network sharing via Link and direct connections to other hosts.

The Link web app allows you to format Lyve Mobile Arrays as ext4, XFS, or exFAT:

1. Open the Link web app.
2. Click **Devices** at the top of the page.
3. Make certain that the Lyve Mobile Array you want to format is unlocked. Click **INSPECT** on a Lyve Mobile Array card.
4. Click **FORMAT** on the Volume card.
5. Acknowledge that formatting the drive will delete all data on the volume.
6. Select the format best suited to your network environment and device usage.
7. Click **START**.

To format as Windows NTFS or macOS HFS+, connect your Lyve Mobile Arrays to the applicable host.



Important—Volumes formatted as APFS or ReFS are not supported by Lyve Mobile Link.



# Appliance Management and IP Addressing

You can connect a PC directly to Link's Appliance Management port for management purposes only. Potential reasons for connecting to the Appliance Management port:

- Your network uses fixed IP addresses.
- You are unable to access the Link web app on the local network.

## Fixed IP addressing

If your network does not include a DHCP server, you must assign an IP address to Lyve Mobile Link's LAN ports (1-3). Make certain you have a token file that allows for signing in to Link before following the instructions below.

1. Connect your computer to the Appliance Management Port on Link via an Ethernet cable.
2. The IP address for Link is 172.31.255.1. Set your PC's IP address to 172.31.255.2 and Netmask 255.255.255.252 to communicate with Link.
3. **Windows PC**—Open a file browser and click **Network**. Click on the Link icon under **Other Devices**. The Link web app will launch in your default browser.  
**Linux and Mac**—Open a web browser and navigate to `https://Link-SerialNumber.local`, replacing *SerialNumber* with the 8-digit serial number found on the label on the bottom of Lyve Mobile Link.
4. Select the token file at the prompt.
5. On the Link web app **Ports** page, you can assign fixed IP addresses to Link's LAN ports (LAN1-3). Note that 172.31.255.[0-255] is reserved for internal Link usage and cannot be assigned to other devices on the network.
6. Disconnect the Ethernet cable when you have made all necessary changes.



**Note**—Link manages the IP addresses for connected Lyve Mobile Arrays.

## Cannot access the Link web app

For troubleshooting purposes, you may need to connect directly to Lyve Mobile Link to determine if there is a problem with IP addressing or some other issue. Make certain that all hardware connections are correct before following the steps below. You must have the token file for Link to sign in to the Link web app.

1. Connect your computer to the Appliance Management Port on Link via an Ethernet cable.
2. The IP address for Link is 172.31.255.1. Set your PC's IP address to 172.31.255.2 and Netmask 255.255.255.252 to communicate with Link.
3. **Windows PC**—Open a file browser and click **Network**. Click on the Link icon under **Other Devices**.

The Link web app will launch in your default browser.

**Linux and Mac**—Open a web browser and navigate to `https://LinkSerialNumber.local`, replacing *SerialNumber* with the 8-digit serial number found on the label on the bottom of Lyve Mobile Link.

4. Select the token file at the prompt.
5. Review the **Ports** page for details regarding the IP address. If you are troubleshooting with the support team, you can download log files on the **Settings** page.
6. Disconnect the Ethernet cable when you are finished.

# Authorize Lyve Mobile Arrays Connected to Other Hosts

If your network environment includes other PCs connected to Lyve Mobile Arrays via PCIe Adapter, fibre channel, or SAS, you can use Lyve Mobile Link to unlock them.

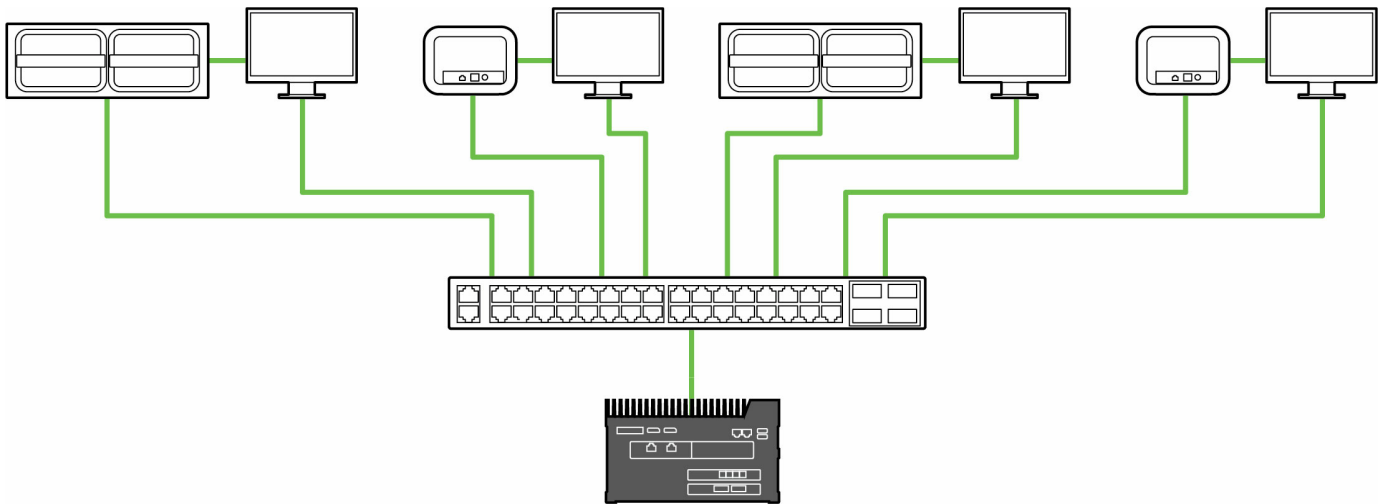

Unlocking can occur under the following conditions:

- All applicable PC hosts and Lyve Mobile Arrays are connected to the same network as Link.
- The Lyve Token file authorizes applicable Lyve Mobile Arrays.

Lyve Mobile Arrays connected to Link's data ports appear in the Link web app as **Connected Devices**.

Lyve Mobile Arrays on the same network and connected to other hosts appear in the web app as **Other Devices**.

The LED on a Lyve Mobile Arrays changes from solid orange to solid green when Link has successfully unlocked the device.

## Lyve Token file delivery

Lyve Token files authorize access to Lyve Mobile Arrays connected to Link. A single token file can authorize multiple Lyve Mobile Arrays or single units. See [Lyve Token Files](#) for more details.

# Regulatory Compliance

## FCC DECLARATION OF CONFORMANCE

This device complies with Part 15 of the FCC Rules. Operation is subject to the following two conditions: (1) this device may not cause harmful interference, and (2) this device must accept any interference received, including interference that may cause undesired operation.

### CLASS A

NOTE: This equipment has been tested and found to comply with the limits for a Class A digital device, pursuant to Part 15 of the FCC Rules. These limits are designed to provide reasonable protection against harmful interference when the equipment is operated in a commercial environment. This equipment generates, uses, and can radiate radio frequency energy and, if not installed and used in accordance with the instruction manual, may cause harmful interference to radio communications. Operation of this equipment in a residential area is likely to cause harmful interference in which case the user will be required to correct the interference at his own expense.