



# LaCie 8big Pro5 User Manual

---



**Click here to access an up-to-date online version** of this document. You will also find the most recent content as well as expandable illustrations, easier navigation, and search capability.

# Contents

<b>1</b>	<b>Introduction</b>	<b>5</b>
	Box content	5
	Minimum requirements	5
<b>2</b>	<b>LaCie 8big Pro5 Advanced Storage</b>	<b>7</b>
<b>3</b>	<b>System Overview</b>	<b>8</b>
	Specifications	8
	• Dimensions	8
	• Weight	8
	• Temperature ranges	8
	• Humidity	8
	• Electrical	9
	Views	9
	• Front	9
	• Back	9
	Storage management	10
<b>4</b>	<b>Status LEDs</b>	<b>11</b>
	LED locations	11
	System LED	11
	Drive LEDs	12
<b>5</b>	<b>Connect LaCie 8big Pro5</b>	<b>14</b>
	Reseat drive drawers	14
	Connect power cord	14
	Connect Thunderbolt cable	15
	Power on	15
	Install LaCie RAID Manager	16
	Format 8big Pro5	17
	• Using the default RAID 5 configuration	17
	• Choosing a different RAID level	17
<b>6</b>	<b>RAID</b>	<b>18</b>
	Standard RAID levels	18
	• RAID 0	18
	• RAID 1	19
	• RAID 5	19
	• RAID 6	20
	Nested RAID levels	21
	• RAID 10	21
	• RAID 50	22
	• RAID 60	22
	• RAID + Spare	23

Drive failures and synchronising a spare hard drive .....	23
---	----

## **7 Initialisation and Formatting ..... 25**

Before you start .....	25
• Driver required .....	25
• Using the default RAID 5 configuration .....	26
• Choosing a different RAID level .....	26
RAID levels requiring initialisation .....	26
Foreground and background initialisation .....	27
• Foreground initialisation .....	27
• Background initialisation .....	27
Format the storage .....	28
• Choose a file system format .....	28
• Learn more .....	29
• Formatting instructions .....	29
• When formatting is required again .....	29

## **8 Operation ..... 30**

Power on .....	30
Safely eject 8big Pro5 volumes from your computer .....	30
• Windows .....	30
• Mac .....	31
• Eject via Finder window .....	31
• Eject via Desktop .....	31
Disconnecting 8big Pro5 from the host computer during operation .....	31
• Normal operation .....	31
• Foreground initialisation .....	31
• Background initialisation .....	31
Power off .....	32
Heat management .....	32
Position and stacking .....	32

## **9 Connectivity and Power Delivery ..... 34**

8big Pro5 compatibility .....	34
• Examples of what you can connect .....	34
Power delivery .....	34

## **10 .Hard Drive Maintenance ..... 36**

Precautions .....	36
Replacing a hard drive .....	36
Non-serviceable components .....	39

## **11 .Frequently Asked Questions ..... 40**

All users .....	40
• Problem: My file transfers are too slow. ....	40
• Thunderbolt 5 .....	40
• USB4 v1 .....	40

- Problem: I want to change the RAID level. .... 41
- Problem: I disconnected my computer from the 8big Pro5 during RAID synchronisation or initialisation. .... 41
- Problem: I have a USB hard drive that I want to connect to a Thunderbolt downstream port. .... 41
- Problem: I must password protect and/or encrypt my hard drive. .... 42
- Mac ..... 42
- Problem: The drive icon does not appear on my desktop. .... 42
- Windows ..... 42
- Problem: The drive icon doesn't appear in Computer. .... 42

**12 .Regulatory Compliance ..... 44**

- FCC DECLARATION OF CONFORMANCE ..... 44
- Class B ..... 44
- R&TTE Directive "Informal DoC" statementR&TTE Directive "Informal DoC" statement ..... 44
- For Australian Customers Only ..... 45
- China Restriction of Hazardous Substances (RoHS) ..... 45
- Taiwan Restriction of Hazardous Substances (RoHS) ..... 46
- VCCI-B ..... 46

# Introduction

Engineered for creative professionals, LaCie 8big Pro5 is a high-performance, multi-bay RAID solution offering exceptional speed, expansive storage capacity, and robust data protection — everything modern creative workflows require.

For common questions and answers about your device, see [Frequently Asked Questions](#) or visit [customer support](#).

## Box content

- LaCie 8big Pro5
- Power cords (US, EU, UK, AU/NZ)
- 1 m Thunderbolt™ 5 (USB-C) cable
- Quick Install Guide

Software can be downloaded at [www.seagate.com/raid-manager](http://www.seagate.com/raid-manager).

## Minimum requirements

You can connect 8big Pro5 to a computer that supports one of the interfaces listed below. 8big Pro5 performance depends upon your computer's USB-C port and operating system.

Interface	Transfer speed
Thunderbolt 5	Up to 80 Gbps
Thunderbolt 4	Up to 40 Gbps
Thunderbolt 3	Up to 40 Gbps
USB4 v2	Up to 80 Gbps
USB4 v1	Up to 40 Gbps

For the latest compatibility details, see [LaCie 8big Pro5 Compatibility](#).



**Mac** – Thunderbolt 3 requires macOS 15 and higher.

**Windows** – Thunderbolt 4 and Thunderbolt 3 require the latest version of Windows 11, as well as the most recent versions of Thunderbolt firmware. If you're unsure which Thunderbolt firmware version is installed on your Windows PC, contact the PC manufacturer. Thunderbolt firmware updates are provided exclusively by the manufacturer.

# LaCie 8big Pro5 Advanced Storage

LaCie 8big Pro5 is engineered to meet the demands of today's creative professionals.

**Big storage for big ideas** — Featuring eight bays of high-capacity Seagate storage, 8big Pro5 is perfect for handling large projects and archiving needs.

**Cutting-edge Thunderbolt 5 technology** — Embrace the future with Thunderbolt 5 and experience ultra-fast data transfer speeds up to 80 Gbps, ideal for data-intensive workflows.

**Powerful connectivity** — With power delivery up to 140 W for the host, and additional power for downstream ports, 8big Pro5 supports a wide range of devices.

**Versatile and expandable** — Ample Thunderbolt 5 and USB 20 Gbps ports let you connect fast storage devices and up to two 8K displays.

**Hardware RAID** — Multiple RAID solutions let you optimise for performance or data protection to suit your project needs. Powerful RAID hardware saves your computer from expending critical processing resources on storage management, which is crucial for video and graphics applications that place heavy demands on computer CPUs.

# System Overview

## Specifications

### Dimensions

Dimension	Measurement
Length	297 mm/11.693 in
Width	232 mm/9.134 in
Height	215 mm/8.465 in

### Weight

Capacity	Measurement
32 TB	13.044 kg / 28.697 lb
64 TB	13.612 kg / 29.946 lb
128 TB	13.324 kg / 29.313 lb
192 TB	13.324 kg / 29.313 lb
240 TB	13.420 kg / 29.524 lb
256 TB	13.420 kg / 29.524 lb

### Temperature ranges

Ambient environment	Temperature range
Standard (operating)	+5°C to +35°C
Storage (non-operating)	-20°C to +60°C

### Humidity

---

Environment	Humidity range
Standard (operating)	10% to 60% non-condensing
Storage (non-operating)	5% to 85% non-condensing

## Electrical

Power rating: 100–240 VAC, 50/60 Hz, 6.5 A, up to 450 W (total)

For more details, see [Connectivity and Power Delivery](#).

## Views

### Front

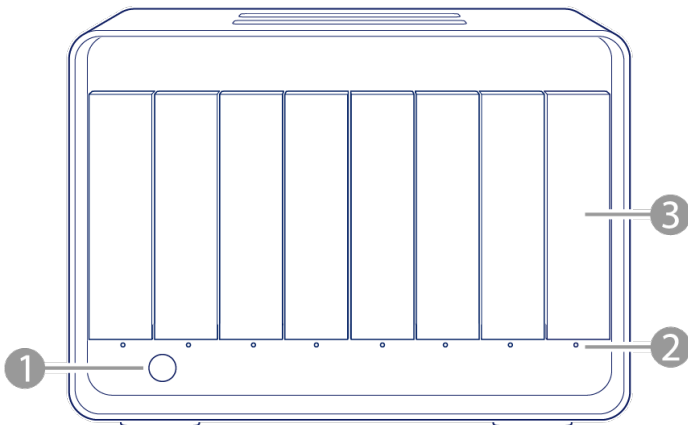

1. **Status LED** – Indicates system status. See [System LEDs](#).
2. **Drive status LEDs** – Indicate hard drive activity and health. See [System LEDs](#).
3. **Drive bays** – Drawers can be removed from their bays to replace hard drives. 8big Pro5 hard drives are hot-swappable. See [Hard Drive Maintenance](#).



The numbers below indicate how drives are identified by [LaCie RAID Manager](#), the application used for managing 8big Pro5.

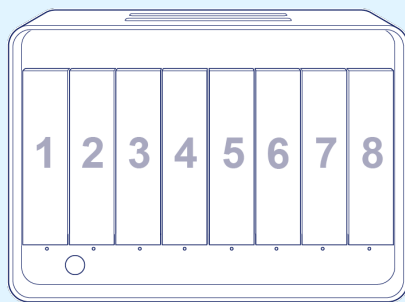

### Back

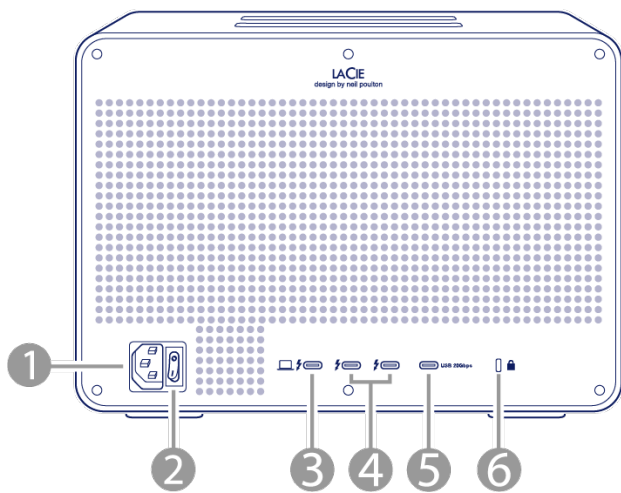

1. **Power input** – Connect the power cable to the power input port. Only use the power cable included with 8big Pro5. See [Connect LaCie 8big Pro5](#).
2. **Power switch** – Use the switch to power 8big Pro5 on/off. See [Operation](#).
3. **Thunderbolt 5 host port** – Use the provided Thunderbolt 5 cable to connect to a compatible port on your host computer. Note that transfer rates vary by the connection type. See [Connect LaCie 8big Pro5](#).
4. **Thunderbolt 5 ports** – Use the Thunderbolt 5 downstream ports to connect external storage devices and displays. The downstream ports also deliver up to 30 W of power to compatible devices. See [Connectivity and Power Delivery](#).
5. **USB 20 Gbps port** – Use the USB 20 Gbps downstream port to connect external storage devices. The port also delivers up to 15 W of power to compatible devices.
6. **Anti-theft lock port:** Use this port to physically lock 8big Pro5 to a desk or rack.

## Storage management

Use LaCie RAID Manager to configure RAID level and manage storage. See the instructions in the [RAID Manager User Manual](#).

# Status LEDs

LEDs provide information on the status of the system and each hard drive.

## LED locations

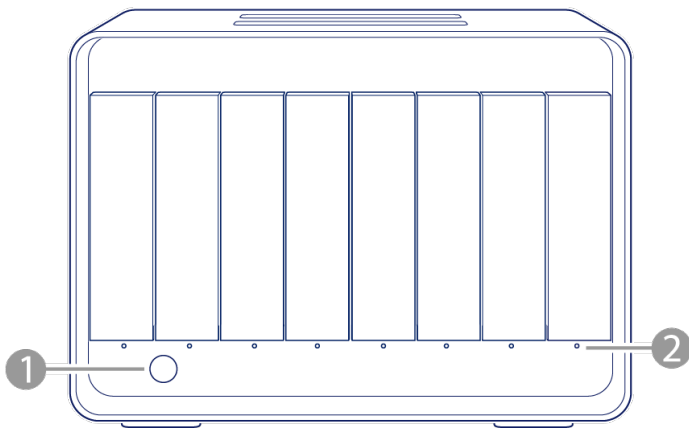

1. **System LED** – Indicates system status.
2. **Drive LEDs** – Indicate hard drive activity and health.

**i** LEDs for this device can be brightened or dimmed using LaCie RAID Manager. See the [RAID Manager User Manual](#) for details.

## System LED

Colour	Pattern	System status
Off	Off	Device is powered off
Blue (2 sec)/Off (2 sec)	Slow Blink	Starting
Blue	Steady	Idling
Blue/Dark Blue	Breathe	Background initialisation
Green/Off	Blink	Foreground initialisation
Light Blue	Steady	Foreground initialisation complete
Purple/Blue	Breathe	RAID rebuilding

Colour	Pattern	System status
Purple	Steady	The array's performance is partially degraded. The array is operating with reduced redundancy but can still tolerate another drive failure. This state typically occurs in a RAID 6 configuration after one drive has failed. Performance may be reduced, but data remains protected.
Magenta	Steady	The array's performance is degraded. The array has lost its redundancy and can no longer tolerate an additional drive failure. This state typically occurs in a RAID 5 configuration after one drive has failed, or in a RAID 6 configuration after two drive failures. Performance is reduced, and data is at risk until the failed drive is replaced and the array is rebuilt.
Orange	Steady	Warning temperature
Red/Off	Blink	Critical temperature
Red	Steady	Emergency temperature, fan not connected, or RAID broken

## Drive LEDs

Colour	Pattern	Drive status
Off	Off	Drive not detected or drive starting
Blue	Steady	Idling
Blue (2 sec)/Off (2 sec)	Slow Blink	Drive detection in progress (normal operation)
Blue (100 ms)/Off (100 ms)	Fast Blink	Drive is being accessed (normal operation)
Blue (1 sec)/Off (2 sec)	Blink	Sector health scan in process
Blue/Dark Blue	Breathe	Background initialisation
Green/Off	Blink	Foreground initialisation
Light Blue	Steady	Foreground initialisation complete
Purple/Off	Blink	RAID rebuilding

Colour	Pattern	Drive status
Purple	Steady	The array's performance is partially degraded. The array is operating with reduced redundancy but can still tolerate another drive failure. This state typically occurs in a RAID 6 configuration after one drive has failed. Performance may be reduced, but data remains protected. Note: All drives in the partially degraded array show the same colour and pattern, even while being accessed.
Purple/Blue	Breathe	Drive is being accessed while the array's performance is partially degraded
Magenta	Steady	The array's performance is degraded. The array has lost its redundancy and can no longer tolerate an additional drive failure. This state typically occurs in a RAID 5 configuration after one drive has failed, or in a RAID 6 configuration after two drive failures. Performance is reduced, and data is at risk until any failed drives are replaced and the array is rebuilt. Note: All drives in the degraded array show the same colour and pattern, even while being accessed.
Magenta/Blue	Breathe	Drive is being accessed while the array's performance is degraded
Orange	Steady	RAID broken
Red	Steady	Emergency temperature or drive is faulty

# Connect LaCie 8big Pro5

## Reseat drive drawers

Drive drawers can shift during shipment. Before you connect 8big Pro5, carefully remove and reinsert each drawer to make sure it is securely seated in its bay.

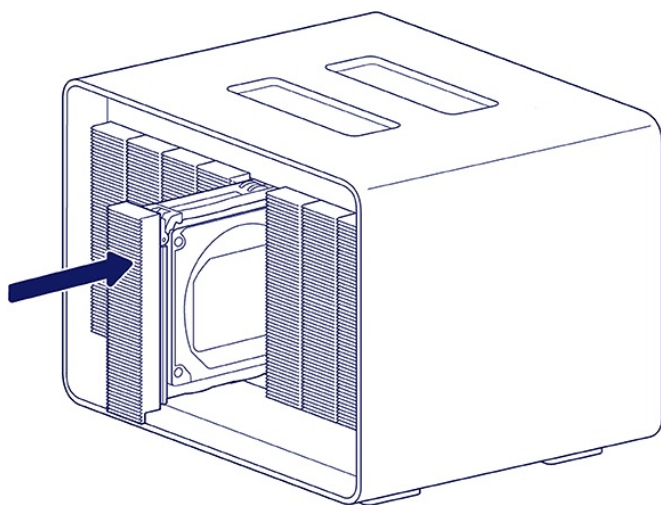
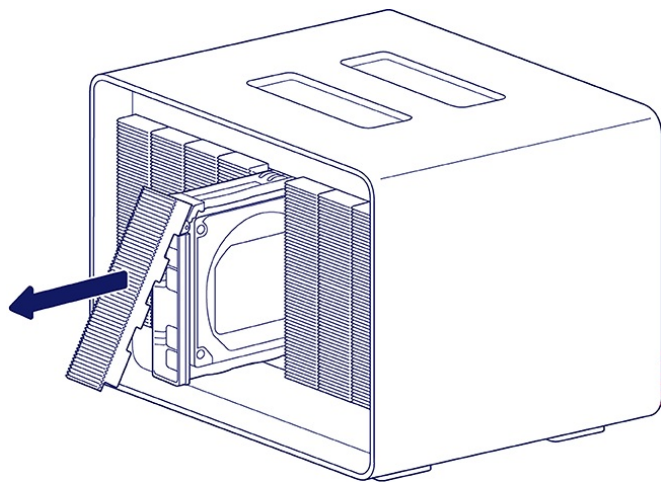

## Connect power cord

- A. Connect power cord to the power input port.
- B. Connect the power cord to a live power socket.

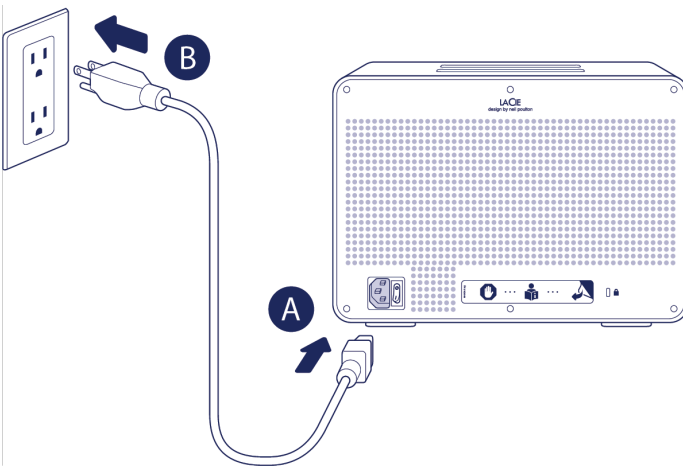

## Connect Thunderbolt cable

A. Remove the sticker covering the ports on the back panel.

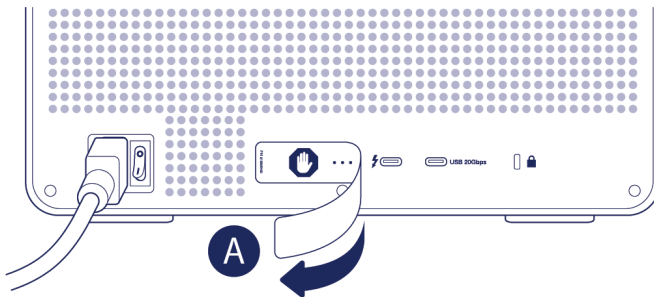

- B. Connect the Thunderbolt 5 cable to the host port on the back panel. Do not connect it to one of the downstream ports.
- C. Connect the other end of the cable to a Thunderbolt 5 port on your Mac or Windows PC. 8big Pro5 also supports connection to a Thunderbolt 3, Thunderbolt 4, or USB4 port.

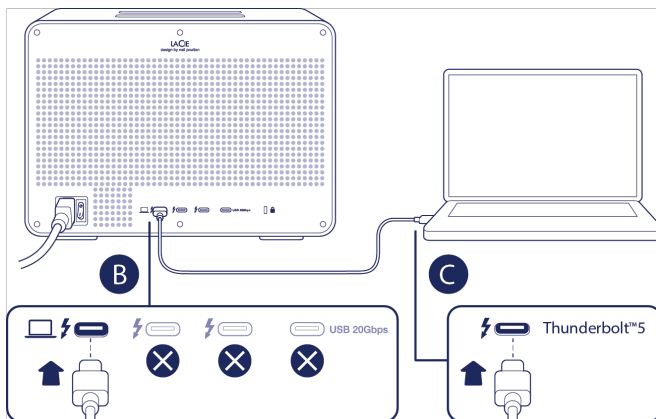

## Power on

Before powering on 8big Pro5, confirm the following:

- All hard drive trays are firmly seated in their bays.
- 8big Pro5's host port is connected to a Thunderbolt 5, Thunderbolt 4, Thunderbolt 3, or USB4 port on your computer.
- The power cable is connected to a powered outlet.

When 8big Pro5 meets the conditions above, turn the power switch to the on position.

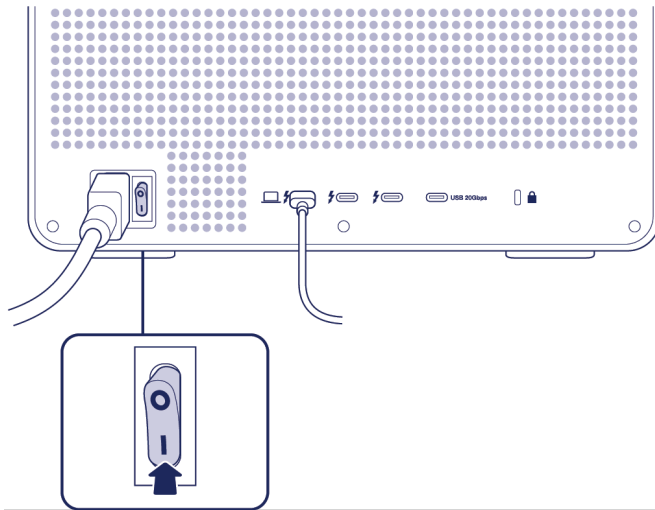

## Install LaCie RAID Manager

Installing LaCie RAID Manager provides a **driver required to access and set up LaCie 8big Pro5**. LaCie RAID Manager also helps you:

- Configure RAID arrays
- Check the health of the storage
- Troubleshoot hard drive issues

To install LaCie RAID Manager:

1. Go to [www.seagate.com/raid-manager](http://www.seagate.com/raid-manager) to download the installer.
2. Launch the installer on the computer that is connected to 8big Pro5.
3. Follow the on-screen instructions to complete the installation.

Once the driver has been installed, the host computer recognises 8big Pro5 as a storage device.



**macOS users** – On macOS, 8big Pro5 may not be recognised immediately because the required Driver Extension (DEXT) may be disabled by default. To enable the driver:

1. Open **System Settings**.
2. Select **General**, then navigate to **Login Items & Extensions**.
3. Under **Extensions**, locate **LaCie Driver Installer**.
4. Click the Info icon and enable the LaCie driver.
5. Enter administrator credentials when prompted.
6. Restart the computer if required.

Once the driver extension is enabled in macOS, 8big Pro5 should be recognised as a storage device.

# Format 8big Pro5

8big Pro5 is delivered **unformatted** with all eight drives configured as a single **RAID 5** array. A spare drive is not assigned to the array. RAID 5 provides data redundancy, helping to protect your files if a hard drive fails. Because some capacity is reserved for redundancy, the usable storage is less than the total device capacity.

Because 8big Pro5 is delivered unformatted, the operating system may prompt you to **initialise** the device for use when it's first detected. In macOS and Windows, the term *initialise* refers to preparing a disk for use by creating a file system, also known as **formatting the storage**.



In LaCie RAID Manager, *initialise* refers to a RAID-level operation **required only when creating or changing parity-based RAID configurations**.

## Using the default RAID 5 configuration

If you are using the preconfigured **default RAID 5** array, you can [format the storage](#) and begin using 8big Pro5.

You can format the array using the operating system's native disk management utility:

- **Disk Utility** on macOS
- **Disk Management** on Windows

LaCie RAID Manager also includes an option to format the array. This option uses the same operating system formatting mechanisms as the native disk utilities.

## Choosing a different RAID level

You can choose a different RAID level to optimise 8big Pro5 for performance or for additional data protection, depending on your working environment. Before allowing macOS or Windows to format 8big Pro5:

- Review the [RAID](#) chapter to determine which RAID level best suits your needs.
- If you choose a different RAID level, use LaCie RAID Manager to select and apply the new RAID level. See instructions in the [RAID Manager User Manual](#).
- Parity-based RAID levels require initialisation. See [Initialisation and Formatting](#) for details.

# RAID

This chapter provides an overview of the RAID levels supported by LaCie 8big Pro5. RAID levels differ in performance, usable storage capacity, and data-protection capabilities, depending on the selected configuration and the number of hard drives in the array.

RAID level	Min. disks	Max. disks	Notes
RAID 0	2	8	
RAID 1	2	2	Only two hard drives are supported for a RAID 1 array.
RAID 5	5	8	A minimum of five hard drives are required to allow for background initialisation as an option.*
RAID 6	7	8	A minimum of seven hard drives are required to allow for background initialisation as an option.*
RAID 10	4	8	
RAID 50	6	8	Can only be created via foreground initialisation.* 8big Pro5 must be disconnected from the host computer during initialisation.
RAID 60	8	8	

\* To better understand the difference between a background initialisation and a foreground initialisation, see [Initialisation and Formatting](#).

Review the summaries for each RAID level before selecting your configuration for 8big Pro5 storage. For instructions on creating or modifying a RAID array, see the [RAID Manager user manual](#).

## Standard RAID levels

### RAID 0

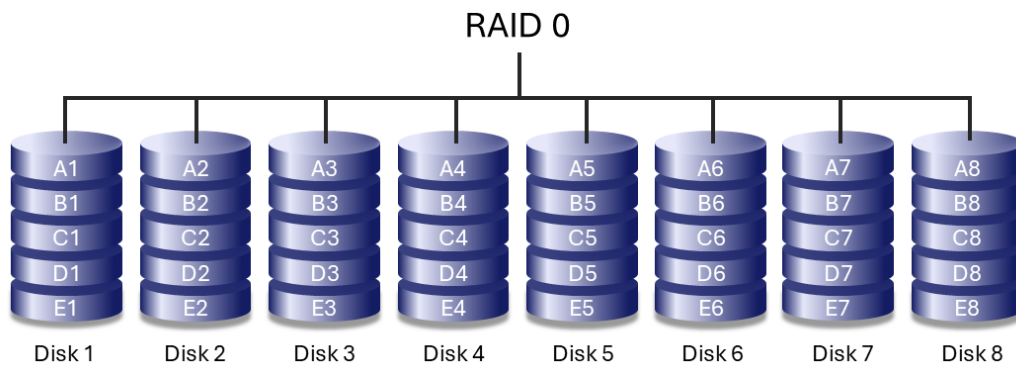

RAID 0 provides the highest sequential performance by writing data across all hard drives in the array (striping). The usable storage capacity equals the combined capacity of all hard drives.

RAID 0 does **not** provide data protection. If a single hard drive fails, all data in the array is lost. RAID 0 is best suited for temporary or non-critical data where performance is the primary requirement and data can be restored from another source.

## RAID 1

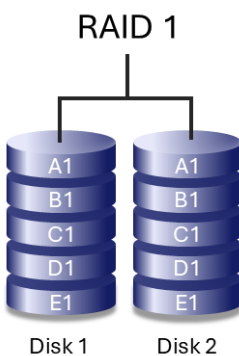

RAID 1 mirrors data between two hard drives, providing enhanced data protection. If one hard drive fails, data remains available on the remaining hard drive.

Because all data is written to both drives, usable storage capacity is reduced by 50%. Write performance is lower than RAID 0, due to the time it takes to write data multiple times. RAID 1 is supported only with two hard drives and cannot be expanded.

## RAID 5

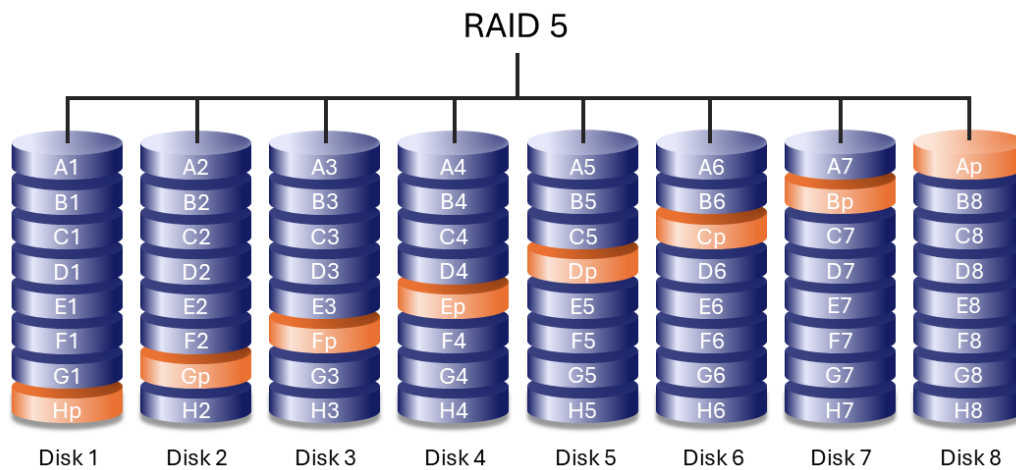

RAID 5 writes data across all hard drives in the array and distributes parity information among them. If one hard drive fails, the array continues to operate and the missing data can be rebuilt onto a replacement hard drive.

If a second hard drive fails before the rebuild process completes, data in the array is lost.



Although some RAID devices support RAID 5 with as few as three hard drives, 8big Pro5 requires a minimum of five hard drives to ensure expected performance and to allow the option of background initialisation. To better understand the difference between a background initialisation and a foreground initialisation, see [Initialisation and Formatting](#).

RAID 5 performance can approach that of RAID 0 while providing protection against a single hard drive failure. Usable capacity is calculated by multiplying the capacity of the smallest hard drive by the total number of hard drives in the array, minus one:

$$\text{Smallest drive capacity} \times (\text{Total number of drives} - 1)$$

Example 1: An array is assigned five 8 TB hard drives for a total of 40 TB. The equation is:

$$8 \text{ TB} \times 4 = 32 \text{ TB}$$

Example 2: An array is assigned four 16 TB hard drives and one 24 TB hard drive for a total of 88 TB. The equation is:

$$16 \text{ TB} \times 4 = 64 \text{ TB}$$

## RAID 6

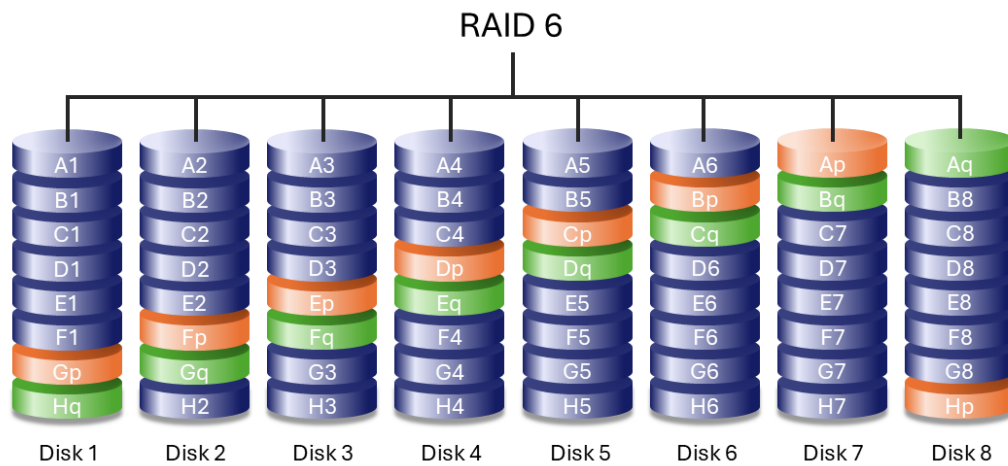

RAID 6 writes data across all hard drives in the array and stores two sets of distributed parity information. This configuration allows the array to withstand the failure of up to two hard drives without data loss.

Rebuilding data after a hard drive failure is slower than RAID 5 due to the additional parity calculations, but RAID 6 provides significantly greater protection for large-capacity arrays.

**i** Although some RAID devices support RAID 6 with as few as four drives, 8big Pro5 requires a minimum of seven hard drives to ensure expected performance and to allow the option of background initialisation. To better understand the difference between a background initialisation and a foreground initialisation, see [Initialisation and Formatting](#).

## Nested RAID levels

### RAID 10

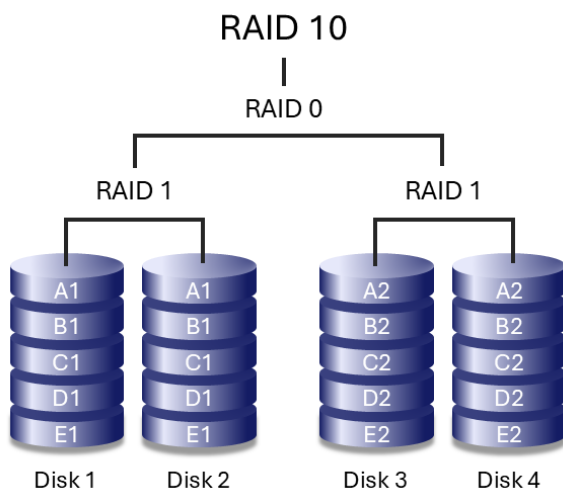

RAID 10 combines the data protection of RAID 1 with the performance benefits of RAID 0. The array is composed of mirrored pairs of hard drives that are then striped together.

RAID 10 can tolerate the failure of one hard drive in each mirrored pair, as long as both drives in the same

mirror do not fail simultaneously. This configuration provides strong data protection and high performance, particularly for workloads that involve frequent access to many small files and benefit from higher input/output operations per second (IOPS).

## RAID 50

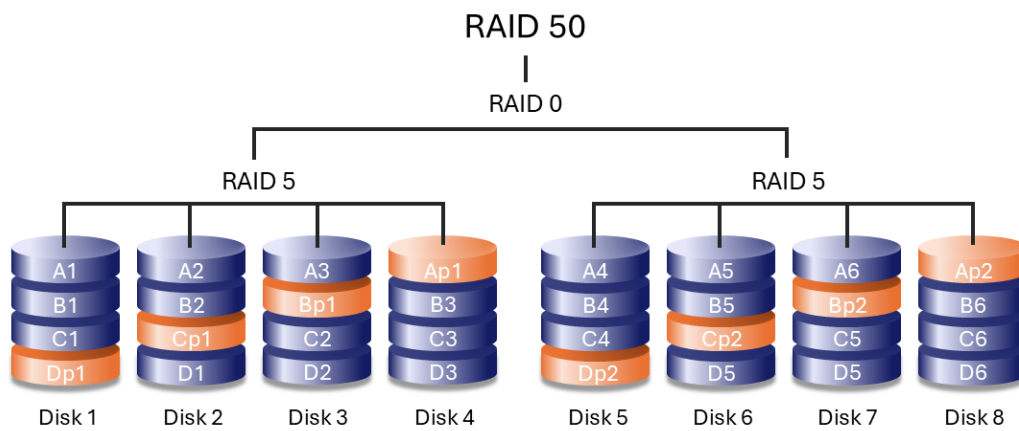

RAID 50 combines RAID 0 striping with RAID 5 parity by striping data across multiple RAID 5 groups. This configuration improves write performance compared to RAID 5 while offering greater fault tolerance than a single RAID level.

A minimum of six hard drives is required. Arrays with a large number of hard drives may take longer to initialise and rebuild due to increased capacity.

RAID 50 can only be created using foreground initialisation. During foreground initialisation, 8big Pro5 must be disconnected from the host computer. For details, see the [RAID Manager User Manual](#).

## RAID 60

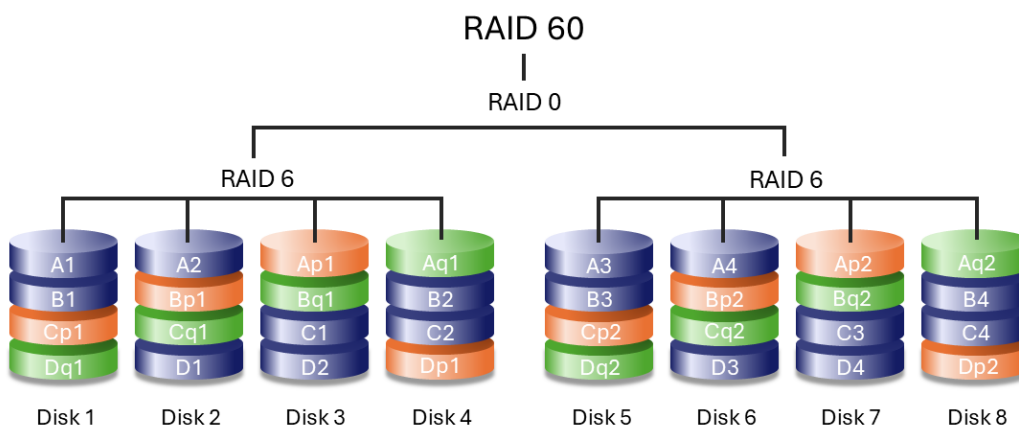

RAID 60 combines RAID 0 striping with RAID 6 double parity by striping data across multiple RAID 6 groups. This configuration offers improved performance compared to RAID 6 while providing high fault tolerance.

A minimum of eight hard drives is required. Because RAID 60 arrays use a large number of hard drives, initialisation and rebuild operations take longer than with standard RAID levels.

RAID 60 can only be created using foreground initialisation. During foreground initialisation, 8big Pro5 must be disconnected from the host computer. For details, see the [RAID Manager User Manual](#).

## RAID + Spare

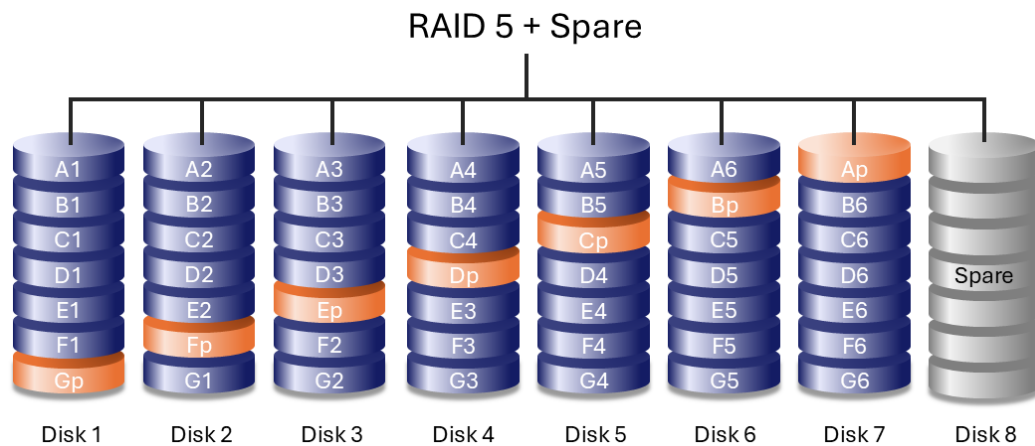

A RAID + Spare configuration includes a reserved hard drive that automatically replaces a failed hard drive. When a hard drive fails, data synchronisation to the spare begins immediately, reducing the time the array operates in a degraded state. Arrays with redundancy that do not include a spare must wait for a replacement drive to start before synchronisation.

- The spare hard drive is not available for data storage during normal operation.
- After synchronisation is complete, you can replace the failed hard drive and assign the new drive as the spare.
- Both dedicated and global spare drives are supported.

See the [RAID Manager user manual](#).

## Drive failures and synchronising a spare hard drive

For RAID + Spare arrays, data remains intact when the minimum number of redundant hard drives fail. However, if an additional hard drive fails before or during data synchronisation with the spare, data in the array is lost. See the examples below.

- **RAIDs 1 and 5** – One drive has failed and the array immediately begins to synchronise with the spare hard drive. If a second hard drive in the RAID 5 array fails before synchronisation is complete, all data in the array is lost.
- **RAID 6** – Two hard drives have failed and the array immediately begins to synchronise the first failed hard drive with the spare. If a third hard drive in the RAID 5 array fails before synchronisation is complete, all data in the array is lost.
- **Nested RAID** – Nested RAID levels have greater fault tolerances depending upon which of the nested RAID arrays have hard drives that fail.
  - **RAIDs 10 and 50** – Each of the nested arrays can lose one hard drive. If one of the two nested arrays loses two hard drives before or during the synchronisation, data is lost.
  - **RAID 60** – Each of the nested arrays can lose two hard drives. If one of the two nested arrays loses three hard drives before or during the synchronisation, data is lost.



# Initialisation and Formatting

Initialisation and formatting are related but distinct processes:

- **Initialisation** prepares a RAID array's internal structure so it can store data reliably. For parity-based RAID levels, initialisation establishes parity information across the array.
- **Formatting** creates a file system on the array so the operating system can read from and write data to it.

Initialisation, when required, occurs before formatting. Formatting alone does not prepare a parity-based RAID array for use.

## Before you start

### Driver required

Installing LaCie RAID Manager provides a **driver required to access and set up LaCie 8big Pro5**. LaCie RAID Manager also helps you:

- Configure RAID arrays
- Check the health of the storage
- Troubleshoot hard drive issues

To install LaCie RAID Manager:

1. Go to [www.seagate.com/raid-manager](http://www.seagate.com/raid-manager) to download the installer.
2. Launch the installer on the computer that is connected to 8big Pro5.
3. Follow the on-screen instructions to complete the installation.

Once the driver has been installed, the host computer recognises 8big Pro5 as a storage device.



**macOS users** – On macOS, 8big Pro5 may not be recognised immediately because the required Driver Extension (DEXT) may be disabled by default. To enable the driver:

1. Open **System Settings**.
2. Select **General**, then navigate to **Login Items & Extensions**.
3. Under **Extensions**, locate **LaCie Driver Installer**.
4. Click the Info icon and enable the LaCie driver.
5. Enter administrator credentials when prompted.
6. Restart the computer if required.

Upon restart, the computer recognises 8big Pro5 as a storage device.

8big Pro5 is delivered **unformatted** with all eight drives configured as a single **RAID 5** array. A spare drive is not assigned to the array. RAID 5 provides data redundancy, helping to protect your files if a hard drive fails. Because some capacity is reserved for redundancy, the usable storage is less than the total device capacity.

Because 8big Pro5 is delivered unformatted, the operating system may prompt you to **initialise** the device for use when it's first detected. In macOS and Windows, the term *initialise* refers to preparing a disk for use by creating a file system, also known as **formatting the storage**.



In LaCie RAID Manager, *initialise* refers to a RAID-level operation required only when creating or changing parity-based RAID configurations.

## Using the default RAID 5 configuration

If you are using the preconfigured default RAID 5 array, you can [format the storage](#) and begin using 8big Pro5.

## Choosing a different RAID level

You can choose a different RAID level to optimise 8big Pro5 for performance or for additional data protection, depending on your working environment. Before allowing macOS or Windows to format 8big Pro5:

- Review the [RAID](#) chapter to determine which RAID level best suits your needs.
- If you choose a different RAID level, use LaCie RAID Manager to select and apply the new RAID level. See instructions in the [RAID Manager User Manual](#).

## RAID levels requiring initialisation

Initialisation is required for RAID levels that use parity. On 8big Pro5, this includes:

- RAID 5
- RAID 6
- RAID 50
- RAID 60

These RAID levels must be initialised using background or foreground initialisation.

The following RAID levels do not require initialisation:

- RAID 0
- RAID 1
- RAID 10

# Foreground and background initialisation

For parity-based RAID levels, you can choose between two initialisation methods:

- A **foreground initialisation** is potentially faster than a background initialisation, but 8big Pro5 must be disconnected from the host while the initialisation runs. 8big Pro5 cannot be accessed during the foreground initialisation.
- A **background initialisation** is typically slower than a foreground initialisation but allows 8big Pro5 to be accessed and used while the initialisation runs.

The availability of foreground or background initialisation depends on the selected RAID level and configuration.

- ! Initialising a RAID array deletes all files stored on the array. Make sure that any files you want to keep are backed up before starting an initialisation.

## Foreground initialisation

When starting a foreground initialisation, **LaCie RAID Manager prompts you to disconnect 8big Pro5 from the host computer**. Foreground initialisation can only be performed when 8big Pro5 is not connected to the host.

- Reconnecting 8big Pro5 to the host computer while a foreground initialisation is in progress **cancels the initialisation sequence**. The initialisation must be **restarted from the beginning**.
- Ensure that 8big Pro5 is connected to a **reliable power source** during the entire process. If power is lost during a foreground initialisation, the initialisation must be **restarted from the beginning**.

LED behaviour during foreground initialisation:

- System LED: Green/Off, breathing
- Drive LEDs: Green/Off, breathing

When the foreground initialisation completes:

- System LED: Light Blue, steady
- Drive LEDs: Light Blue, steady

- ! Do not disconnect power during a foreground initialisation. Losing power will require the initialisation process to be restarted. Reconnect 8big Pro5 to the host computer **only after the LEDs indicate that the foreground initialisation is complete** (System and Drive LEDs are light blue and steady).

## Background initialisation

During a background initialisation, 8big Pro5 remains usable with some limitations:

- 8big Pro5 can be safely ejected from the host computer and continues initialising as long as the device remains powered on.
- The device can be disconnected and reconnected to the host computer while background initialisation is in progress.
- If 8big Pro5 is powered off during a background initialisation, the process resumes from where it left off when power is restored.

During background initialisation, expect reduced performance until the process completes.

LED behaviour during background initialisation:

- System LED: Blue/Dark Blue, breathing
- Drive LEDs: Blue/Dark Blue, breathing

## Format the storage

You can format the array using the operating system's native disk management utility:

- **Disk Utility** on macOS
- **Disk Management** on Windows

LaCie RAID Manager also includes an option to format the array. This option uses the same operating system formatting mechanisms as the native disk utilities.



Formatting the array using LaCie RAID Manager will ensure that branded 8big Pro5 icons are displayed in Finder/File Explorer.

## Choose a file system format

Choose a file system format based on the operating system you use with 8big Pro5.

- **macOS** — Format the drive using **APFS (Apple File System)**. APFS is an Apple file system optimised for solid state drives (SSDs) and flash-based storage systems, though it also works with hard disk drives (HDDs). It was first introduced with the release of macOS High Sierra (version 10.13). APFS can only be read by Macs running High Sierra or later. Windows cannot natively read or write to APFS volumes.
- **Windows** — Format the drive using **NTFS (New Technology File System)**. NTFS is a proprietary journalling file system for Windows. macOS can read NTFS volumes, but it can't natively write to them. This means your Mac can copy files from an NTFS-formatted drive, but it can't add files to or remove files from the drive.

8big Pro5 does not support a cross-platform file system format. To ensure proper operation and optimal performance, format the drive using the native file system of your operating system.

## Learn more

For additional considerations when choosing a file system format, see [File System Format Comparisons](#).

## Formatting instructions

For instructions on formatting your drive, see [How to format your drive](#)



Formatting deletes all data on the array. Before formatting, make sure that any files you want to keep are backed up. If the array was newly initialised or the RAID level was changed, all previous data has already been erased as part of that process.

## When formatting is required again

Formatting is required whenever the structure of the storage array changes or when you want to apply a different file system. Common scenarios include:

- Changing the RAID level
- Replacing all drives in the array
- Preparing the device for use with a different operating system

Changing the RAID level deletes all data on the array and requires **formatting** before the array can be used again. Parity-based RAID levels will require **initialisation** before formatting.

# Operation

## Power on

Before powering on LaCie 8big Pro5, confirm the following:

- All hard drive drawers are firmly seated in their bays.
- 8big Pro5's host port is connected to a compatible port on your computer.
- The power cable is connected to a powered outlet.

When 8big Pro5 meets the conditions above, turn the power switch to the on position.

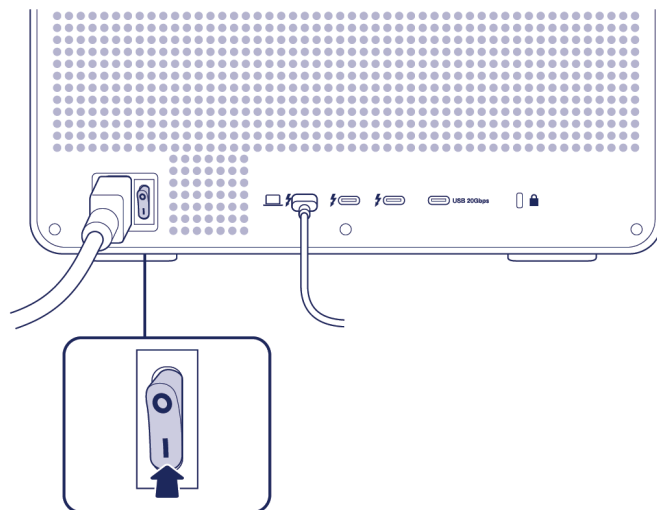

The drive status LEDs blink blue while the disks spin up. You can start using the storage once all LEDs are solid blue.

**!** **Caution:** Do not operate 8big Pro5 until the ambient temperature is within the specified temperature range (see [System Overview](#)). If the hard drives were installed recently, make sure they have time to acclimatise to the ambient temperature before operating them.

## Safely eject 8big Pro5 volumes from your computer

Always safely eject 8big Pro5 from your computer before powering down or physically disconnecting it. Your computer must perform filing and housekeeping operations before 8big Pro5 is removed. If you unplug the drive without using the operating system's software, your files can become corrupt or damaged.

## Windows

Use the Safely Remove tool to eject a device.

1. Click the Safely Remove Hardware icon in your Windows System Tray to view the devices you can eject.
2. If you don't see the Safely Remove Hardware icon, click the Show hidden icons arrow in the system tray to display all icons in the notification area.
3. In the list of devices, choose the device you want to eject. Windows displays a notification when it is safe to remove the device.
4. Disconnect 8big Pro5 from the computer.

## Mac

There are several ways you can eject your device from a Mac. See below for two options.

### Eject via Finder window

1. Open a Finder window.
2. Using the sidebar, click Locations and find the drive you want to eject. Click the eject symbol to the right of the drive name.
3. Once the device disappears from the sidebar or the Finder window closes, you can disconnect 8big Pro5 from the computer

### Eject via Desktop

1. Select the desktop icon for your device and drag it to the Trash icon.
2. When the device icon is no longer visible on your desktop, you can physically disconnect 8big Pro5 from the computer.

## Disconnecting 8big Pro5 from the host computer during operation

### Normal operation

Disconnecting 8big Pro5 from the host computer during normal operation can result in data loss. Always safely eject 8big Pro5 from your computer before powering down or physically disconnecting it.

### Foreground initialisation

When starting a foreground initialisation, LaCie RAID Manager will prompt you to disconnect 8big Pro5 from the host computer. Foreground initialisations can only be performed when 8big Pro5 is no longer connected to the host. Reconnecting 8big Pro5 to the host computer while the foreground initialisation is running will cancel the initialisation sequence. In addition, make certain that 8big Pro5 is connected to a secure power supply during a foreground initialisation. Losing power during a foreground initialisation will require a fresh restart of the initialisation process.

### Background initialisation

During a background initialisation, 8big Pro5 can be safely ejected from the host computer and continues initialising as long as the device is powered on. It may also be disconnected and reconnected to the host while a background initialisation is in progress. If the device is powered off during a background initialisation, the process resumes from where it left off when power is restored.

## Power off

Make certain that 8big Pro5 is not in use and that there are no active transfers.

1. Safely eject 8big Pro5 volumes from your computer.
2. Turn the power switch OFF.

It is now safe to disconnect the power cord and Thunderbolt cable from the device.

**!** **Warning** – Do not power off the device while it is transferring data as it may result in corrupted data.

## Heat management

To reduce noise during operation, 8big Pro5 uses two cooling fans to pull heat away from the internal components. The cooling fans are temperature controlled, which guarantees optimal heat management by adjusting the rotational speed for the environment. Additionally, 8big Pro5's enclosure dissipates heat from the hard drives to prolong their life. Since the enclosure draws heat away from the internal hard drives, it may be warm to the touch after extended use.

**!** **Important** – The wide exhaust chamber on the back of 8big Pro5 allows for enhanced airflow. Make sure that it is not obstructed and that there is a natural airflow across the external surface.

## Position and stacking

Always place 8big Pro5 on a flat, stable surface that supports proper airflow and heat dissipation. The enclosure is designed to operate only when resting on its rubber feet.

- **Do not operate 8big Pro5 vertically.** Vertical positioning is not supported under any circumstances. Placing the enclosure on its side will damage the device and the installed hard drives.

**!** **Placing the enclosure on its side will damage the device and the installed hard drives.**

- **Supported stacking is limited to two units.** You may stack one 8big Pro5 on top of another (a

maximum of two units). Stacking more than two enclosures is not supported and can increase the risk of instability or device damage.

- **Do not place heavy equipment on top of 8big Pro5.** Avoid stacking heavy equipment on top of 8big Pro5.



Placing any objects on top of 8big Pro5 risks scratching the enclosure. Damages to the enclosure are not covered by warranty.

# Connectivity and Power Delivery

Thunderbolt 5 is the next evolution of Thunderbolt technology, building on the advances of Thunderbolt 4. While Thunderbolt 4 delivers up to 40 Gbps of bidirectional bandwidth, Thunderbolt 5 significantly expands available throughput. It supports up to 80 Gbps bidirectional bandwidth for data transfers, and can dynamically scale to as much as 120 Gbps of total throughput when combining data and high-bandwidth display traffic – enabling demanding workflows such as high-resolution video editing, multi-display configurations, and large data transfers.

Additional Thunderbolt-compatible cables (not included) are required.

## 8big Pro5 compatibility

8big Pro5 provides two downstream Thunderbolt 5 ports and one downstream USB 20 Gbps (USB 3.2 Gen 2x2) port, enabling flexible expansion for storage, displays and high-speed peripherals. All downstream ports support devices that are USB 3.x and higher. Thunderbolt devices can be connected only to the Thunderbolt 5 downstream ports, which are backward compatible with Thunderbolt 4, Thunderbolt 3 and USB4. Connected peripherals operate at their own maximum supported speed rather than at Thunderbolt 5's peak performance.

## Examples of what you can connect

**i** Assume a compatible host with appropriate GPU/OS support and up-to-date Thunderbolt firmware. Actual device counts, resolutions, and speeds depend on host, cable and device capabilities.

- **Connect up to four devices** using the two Thunderbolt 5 ports and the USB 20 Gbps port
- **Support multiple displays**, up to three 4K monitors or two 8K monitors
- **Connect high-speed external SSDs**, including Thunderbolt 5 models such as LaCie Rugged SSD Pro5 and USB4 models such as LaCie Rugged SSD4
- **Daisy-chain two devices from a single Thunderbolt 5 port**, for example, a high-speed SSD and a display
- **Connect USB 20 Gbps devices** via the integrated USB-C hub port

## Power delivery

8big Pro5 must be connected to AC power via its power cable to deliver power to compatible devices.

Port	Power delivery
------	----------------

Thunderbolt 5 host port	Up to 140W
Thunderbolt 5 downstream ports	Up to 30 W (each)
USB 20 Gbps downstream port	Up to 15W



**Important info:** LaCie is not responsible for devices that experience harm, damage, or malfunction when connected to 8big Pro5.

# Hard Drive Maintenance

## Precautions

- **Hot-swapping** refers to removing and replacing hard drives while the enclosure is powered on. LaCie 8big Pro5 features hot-swappable hard drives.
- During operation, the hard drives should remain in their bays for optimal airflow. Airflow and fan performance are regulated by temperature.
- Observe all conventional electrostatic discharge (ESD) precautions when handling hard drives.

## Replacing a hard drive

Replace a hard drive if:

- You want to expand the available storage space by adding hard drives with a larger capacity.
- The hard drive has failed.

If a failed hard drive is under warranty, make certain to contact [Seagate support](#) about receiving a replacement disk.

When adding new hard drives or replacing hard drives that are not under warranty, consider using Seagate Enterprise HDDs that are optimised for use with 8big Pro5. For further information about compatible hard drives, see [LaCie Big Products - Drive Compatibility List](#)



**Important** — Replace a faulty hard drive with a hard drive of equal or greater capacity.

Since 8big Pro5 supports hot swapping hard drives, it is not necessary to power down the device to replace a single hard drive.



**Important** — When handling hard drives, make sure that they are placed and stored on a cushioned surface.

1. Locate the drive you want to replace and place your index finger under the drawer cover.

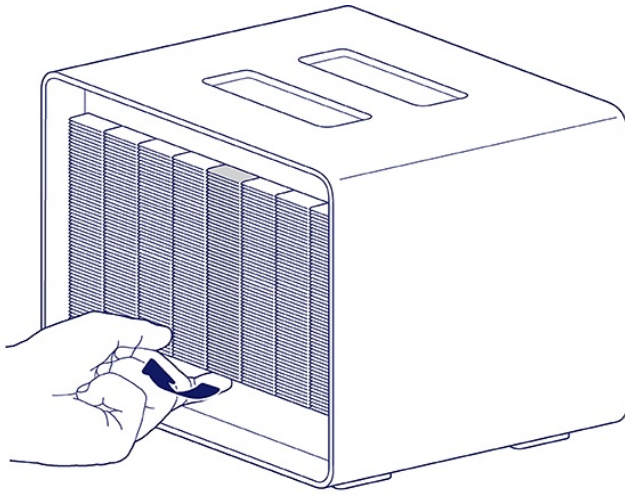

2. Gently pull the bottom of the cover and slide the drive drawer out of the bay.

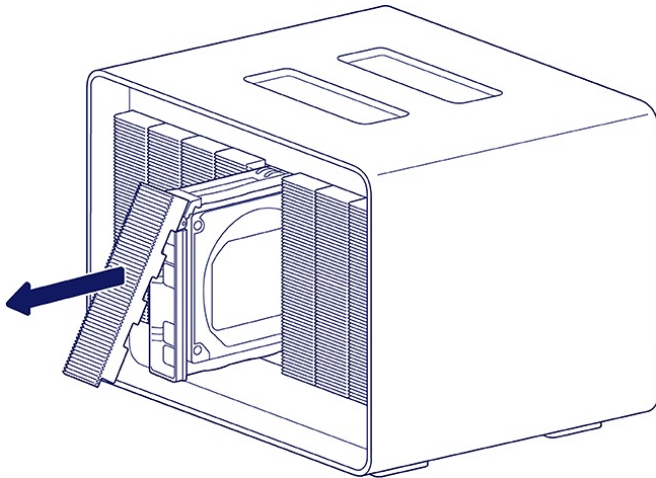

3. Turn the drawer over so that the drive label is facing down.

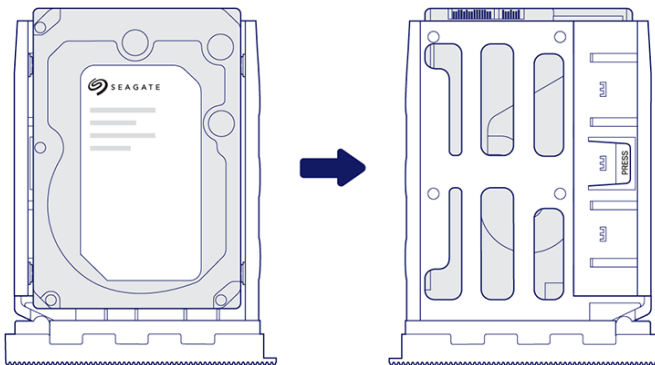

4. Hold the drawer with both hands just above your working surface. Press the tab marked **PRESS** and pull the sides of the drive drawer outward until the drive is released.

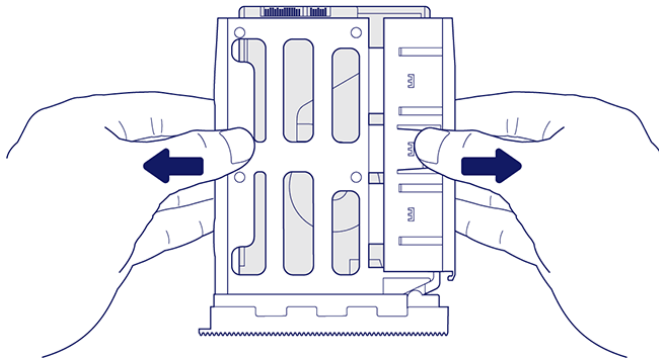
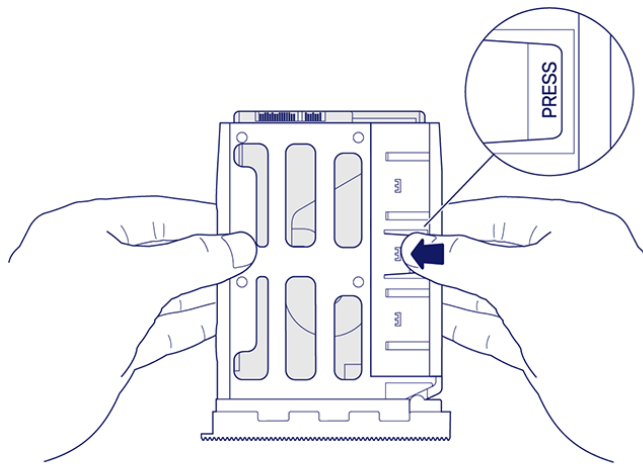

5. Place the empty drawer on your working surface with the open side facing up. Set the replacement drive in the drawer (label side up) and slide the drive down until it is seated against the drawer cover.

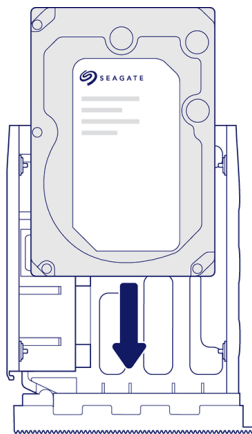

6. Push the sides of the drive drawer inward until the drive is locked in place.

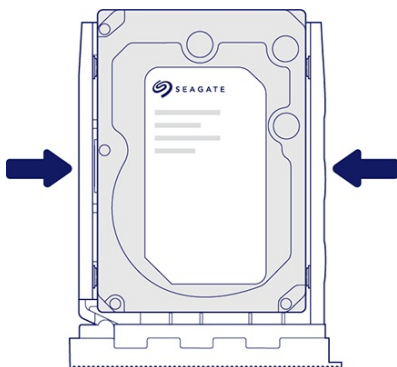

7. Carefully insert the full drawer into the bay. Push firmly on the cover until the drawer is fully inserted and the drive is seated.

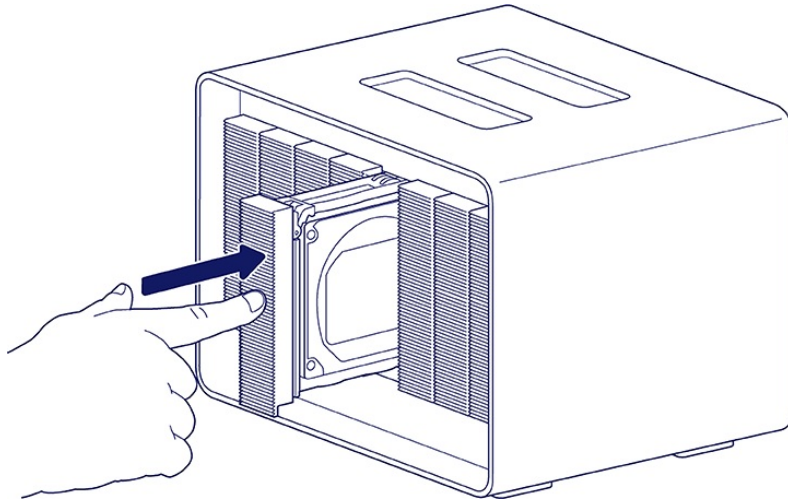

When replacing hard drives that are members of an active RAID array, the hard drive LEDs blink red and blue indicating that the RAID is synchronising data. You can continue to use the 8big Pro5 storage, but performance is reduced until the synchronisation is complete.

## Non-serviceable components

The components inside the 8big Pro5's chassis are **NOT** hot-swappable and are not serviceable at any location outside of Seagate-approved service centres. **Removing the cover voids your product's warranty**. Additionally, removing, replacing or changing any part in the enclosure or, performing any action that involves the components in the enclosure, voids the product's warranty. If you are experiencing hardware errors or failure, contact [Seagate support](#) for assistance.

# Frequently Asked Questions

For help setting up and using LaCie 8big Pro5, review the frequently asked questions below. For additional support resources, go to [customer support](#).

## All users

### Problem: My file transfers are too slow.

#### Thunderbolt 5

**Q:** Are both ends of the cable firmly attached?

**A:** Review troubleshooting tips for cable connections below:

- Check to make sure you are using the provided Thunderbolt 5 cable.
- Check both ends of the cable and make sure they are fully seated in their respective ports.
- Try safely ejecting 8big Pro5 from your computer and then disconnect the cable. Wait 10 seconds and then reconnect to the computer.

**Q:** Are there other Thunderbolt or USB devices connected to 8big Pro5?

**A:** Disconnect other devices and see if performance improves.

**Q:** Is the device connected to a Thunderbolt 5 port on your computer or hub?

**A:** Connect 8big Pro5 to a compatible USB-C port on your computer or hub that supports Thunderbolt 5, Thunderbolt 4, Thunderbolt 3 or USB4. A lightning bolt icon next to the port indicates Thunderbolt support.

When connected to any of these supported ports, the performance of the internal hard drives will be similar. However, if you connect Thunderbolt 5 devices to 8big Pro5's downstream ports, their performance may be limited by the capabilities of the host computer or hub. For example, Thunderbolt 5 devices connected through a Thunderbolt 4, Thunderbolt 3, or USB4 host will operate at the maximum speeds supported by that host.

**Q:** Does your computer or operating system support Thunderbolt 5?

**A:** Consult your computer and operating system documentation for Thunderbolt 5 compatibility information.

#### USB4 v1

**Q:** Is the device connected to USB4 v1 port on your computer or hub?

**A:** When 8big Pro5 is connected to a USB4 v1, USB4 v2, Thunderbolt 3, Thunderbolt 4, or Thunderbolt 5 host, the performance of the internal hard drives is effectively the same. Differences in connection type do not significantly affect hard-drive performance in the array.

Performance differences become noticeable when using high-speed external solid-state devices, such as Thunderbolt 5 SSDs, connected to the downstream Thunderbolt 5 ports. These devices achieve their best performance only when 8big Pro5 itself is connected to a Thunderbolt 5 host. When connected through a USB4 v1, USB4 v2, Thunderbolt 4, or Thunderbolt 3 host, downstream device performance is limited by the capabilities of that host connection.

## Problem: I want to change the RAID level.

**Q:** How do I change the RAID level?

**A:** You can manage the storage for 8big Pro5 using LaCie RAID Manager. To download the installer, go to [LaCie RAID Manager](#). For instructions on how to use the application, see the [LaCie RAID Manager user manual](#).

## Problem: I disconnected my computer from the 8big Pro5 during RAID synchronisation or initialisation.

**Q:** Can I disconnect my computer during RAID synchronisation or initialisation?

**A:** It depends on the type of initialisation in progress.

### Foreground initialisation

When you start a foreground initialisation, LaCie RAID Manager prompts you to disconnect 8big Pro5 from the host computer. Foreground initialisation can only proceed while the device is disconnected from the host.

You can monitor progress by observing the system and drive LEDs. During the foreground initialisation, the LEDs cycle between green and off in a breathing pattern. When initialisation is complete, the LEDs turn solid white.

Make sure that 8big Pro5 remains connected to a stable power source throughout the process. If power is lost during a foreground initialisation, the initialisation must be restarted from the beginning. Reconnecting 8big Pro5 to the host computer before the process completes will cancel the initialisation.

### Background initialisation

During a background initialisation, you can safely eject 8big Pro5 from the host computer. Initialisation continues as long as the device remains powered on. You may disconnect and reconnect the device to the host while the background initialisation is in progress.

If 8big Pro5 is powered off during a background initialisation, the process automatically resumes from where it left off when power is restored.

## Problem: I have a USB hard drive that I want to connect to a Thunderbolt downstream port.

**Q:** Can I attach my USB hard drive to a Thunderbolt downstream port?

**A:** Yes. Note that USB-C devices do not become Thunderbolt devices when connected to a Thunderbolt 5 downstream port. The USB device can only provide performance within its potential. For example, a USB

3.1 Gen 1 drive added to the end of a Thunderbolt downstream port can reach up to 5 Gbps, while a USB 3.1 Gen 2 drive can reach up to 10 Gbps.

## Problem: I must password protect and/or encrypt my hard drive.

Q: Can I encrypt my hard drive?

A: Yes, the hard drive can be encrypted. There are many third-party solutions for encryption. However, Seagate cannot guarantee them as third-party applications are not tested.

## Mac

### Problem: The drive icon does not appear on my desktop.

Q: Is your Finder configured to hide hard drives on the desktop?

A: Go to Finder and then check **Preferences > General tab > Show these items on the desktop** Confirm that **Hard Disks** is selected.

Q: Is your drive mounting in the operating system?

A: Open Disk Utility at **Go > Utilities > Disk Utility**. If the drive is listed in the left-hand column, check your Finder preferences to see why it is not displayed on the desktop (review the question above).

Q: Does your computer's configuration meet the minimum system requirements for use with this drive?

A: Refer to the product packaging for the list of supported operating systems.

Q: Did you follow the correct installation steps for your operating system?

A: Review the installation steps in [Connect LaCie 8big Pro5](#).

## Windows

### Problem: The drive icon doesn't appear in Computer.

Q: Is the drive listed in Device Manager?

A: All drives appear in at least one place in Device Manager.

Go to Search to type Device Manager and then launch it. Look in the Disk Drives section and, if necessary, click the plus sign to view the full list of devices. If you're uncertain that your drive is listed, safely unplug it and then reconnect it. The entry that changes is your LaCie hard drive.

Q: Is your drive listed next to an unusual icon?

A: Windows Device Manager usually provides information about failures with peripherals. While the Device Manager can assist with troubleshooting most problems, it may not display the exact cause or provide a precise solution.

An unusual icon next to the hard drive can reveal a problem. For example, instead of the normal icon based on the type of device, it is instead an exclamation point, question mark or an X. Right-click this icon and then choose **Properties**. The **General** tab provides a potential reason why the device is not working as expected.

# Regulatory Compliance

Equipment Name	External Disk Array
Regulatory Model Number	LRDAC01

## FCC DECLARATION OF CONFORMANCE

This device complies with Part 15 of the FCC Rules. Operation is subject to the following two conditions: (1) this device may not cause harmful interference, and (2) this device must accept any interference received, including interference that may cause undesired operation.

### Class B

This equipment has been tested and found to comply with the limits for a Class B digital device, pursuant to Part 15 of the FCC Rules. These limits are designed to provide reasonable protection against harmful interference in residential installation. This equipment generates, uses, and can radiate radio frequency energy and, if not installed and used in accordance with the instructions, may cause harmful interference to radio communications.

However, there is no guarantee that interference will not occur in a particular installation. If this equipment does cause harmful interference to radio or television reception, which can be determined by turning

the equipment off and on, the user is encouraged to try to correct the interference by one or more of the following measures:

- Reorient or relocate the receiving antenna.
- Increase the separation between the equipment and receiver.
- Connect the equipment into an outlet on a circuit different from that to which the receiver is connected.
- Consult the dealer or an experienced radio/TV technician for help.

**CAUTION:** Any changes or modifications made to this equipment may void the user's authority to operate this equipment.

## R&TTE Directive "Informal DoC" statement R&TTE Directive "Informal DoC" statement

Hereby, Seagate declares that this product is in compliance with the essential requirements and other relevant provisions of Directive 1999/5/EC. For details, please access the following:

## For Australian Customers Only

Our goods come with guarantees that cannot be excluded under the Australian Consumer Law. You are entitled to a replacement or refund for a major failure and for compensation for any other reasonably foreseeable loss or damage. You are also entitled to have the goods repaired or replaced if the goods fail to be of acceptable quality and the failure does not amount to a major failure.

Revision - July 1, 2020

## China Restriction of Hazardous Substances (RoHS)



China RoHS 2 refers to the Ministry of Industry and Information Technology Order No. 32, effective July 1, 2016, titled Management Methods for the Restriction of the Use of Hazardous Substances in Electrical and Electronic Products. To comply with China RoHS 2, we determined this product’s Environmental Protection Use Period (EPUP) to be 20 years in accordance with the Marking for the Restricted Use of Hazardous Substances in Electronic and Electrical Products, SJT 11364-2014.

中国 RoHS 2 是指 2016 年 7 月 1 日起施行的工业和信息化部令第 32 号“电力电子产品限制使用有害物质管理办法”。为了符合中国 RoHS 2 的要求，我们根据“电子电气产品有害物质限制使用标识”(SJT 11364-2014) 确定本产品的环保使用期 (EPUP) 为 20 年。

产品中有害物质的名称及含有的信息表 Names and information of hazardous substances in product										
有害物质      Hazardous Substances										
部件名称 Part Name	铅 (Pb)	汞 (Hg)	镉 (Cd)	六价铬 (Cr <sup>6+</sup> )	多溴联苯 (PBBs)	多溴二苯醚 (PBDEs)	邻苯二甲酸 苯基丁基酯 (DBP)	邻苯二甲酸二 异丁酯 (DIBP)	邻苯二甲酸 甲基丁基酯 (BBP)	邻苯二甲酸二 (2-乙基己基)酯 (DEHP)
硬盘驱动器 HDD	X	○	○	○	○	○	○	○	○	○
外接硬盘印刷电路板 Bridge PCBA	X	○	○	○	○	○	○	○	○	○
电源(如果提供) Power Supply (if provided)	X	○	○	○	○	○	○	○	○	○
接口电缆(如果提供) Interface cable (if provided)	○	○	○	○	○	○	○	○	○	○
其他外壳组件 Other enclosure components	○	○	○	○	○	○	○	○	○	○

**注 1:** ○: 表示该有害物质在该部件所有均质材料中的含量均不超出电器电子产品有害物质限制使用国家标准要求。  
X: 表示该有害物质至少在该部件的某一均质材料中的含量超出电器电子产品有害物质限制使用国家标准要求。

**注 2:** 以上未列出的部件, 表明其有害物质含量均不超出电器电子产品有害物质限制使用国家标准要求。

**Note 1:** ○: Indicates that the content of the hazardous substance in all homogeneous materials of this component does not exceed the requirements of the national standard for the restricted use of hazardous substances in electrical and electronic products.  
X: Indicates that the content of the hazardous substance in at least one homogeneous material of this component exceeds the requirements of the national standard for the restricted use of hazardous substances in electrical and electronic products.

**Note 2:** For components not listed above, their hazardous substance content does not exceed the requirements of the national standard for the restricted use of hazardous substances in electrical and electronic products.

# Taiwan Restriction of Hazardous Substances (RoHS)

Taiwan RoHS refers to the Taiwan Bureau of Standards, Metrology and Inspection's (BSMI's) requirements in standard CNS 15663, Guidance to reduction of the restricted chemical substances in electrical and electronic equipment. Beginning on January 1, 2018, Seagate products must comply with the "Marking of presence" requirements in Section 5 of CNS 15663. This product is Taiwan RoHS compliant. The following table meets the Section 5 "Marking of presence" requirements.

台灣RoHS是指台灣標準局計量檢驗局(BSMI)對標準CNS15663要求的減排電子電氣設備限用化學物質指引。從2018年1月1日起, Seagate產品必須符合CNS15663第5節「含有標示」要求。本產品符合台灣RoHS。下表符合第5節「含有標示」要求。

設備名稱: 外接式磁碟陣列, 型號: LRDAC01 Equipment Name: External Disk Array, Model: LRDAC01							
單元 Unit	限用物質及其化學符號 Restricted Substance and its chemical symbol						
	鉛 Lead (Pb)	汞 Mercury (Hg)	鎘 Cadmium (Cd)	六價鉻 Hexavalent chromium (Cr <sup>6+</sup> )	多溴聯苯 Polybrominated biphenyls (PBB)	多溴二苯醚 Polybrominated diphenyl ethers (PBDE)	
硬盤驅動器 HDD	—	○	○	○	○	○	
外接硬盤印刷電路板 Bridge PCBA	—	○	○	○	○	○	
電源 (如果提供) Power Supply (if provided)	—	○	○	○	○	○	
傳輸線材 (如果提供) Interface cable (if provided)	○	○	○	○	○	○	
其他外殼組件 Other enclosure components	○	○	○	○	○	○	

備考1. "超出0.1 wt%"及"超出0.01 wt%"係指限用物質之百分比含量超出百分比含量基準值。  
Note 1: "Exceeding 0.1 wt%" and "exceeding 0.01 wt%" indicate that the percentage content of the restricted substance exceeds the reference percentage value of presence condition.

備考2. "○"係指該項限用物質之百分比含量未超出百分比含量基準值。  
Note 2: "○" indicates that the percentage content of the restricted substance does not exceed the percentage of reference value of presence.

備考3. "—"係指該項限用物質為排除項目。  
Note 3: The "—" indicates that the restricted substance corresponds to the exemption.

額定電壓/額定電流: 100~240Vac == 6.5A 50/60Hz      操作溫度: 5 to 35°C

本設備勿置於潮濕處。  
請將產品置於手冊規定的環境使用溫度, 以避免過熱。  
連接至電源前, 請先檢查電壓。  
當設備不用時, 請將所有電源線拔除, 避免電壓不穩而造成傷害。  
勿將任何液體濺入設備中, 避免線路短路。  
請勿自行調整或修理已通電的設備, 以確保您的安全。

## VCCI-B

この装置は、クラスB機器です。この装置は、住宅環境で使用することを目的としていますが、この

装置がラジオやテレビジョン受信機に近接して使用されると、受信障害を引き起こすことがあります。取扱説明書に従って正しい取り扱いをして下さい。VCCI-B